

RECOMMENDED P.C. BOARD PATTERN DIM.

Specifications

Electrical

Voltage Rating: 50V(AC)
 Current Rating: 1.0A
 Contact Resistance: 20mΩ max.
 Dielectric Withstanding Voltage: 500V AC/1min.
 Insulation Resistance: 100M Ω min.

Material and Finish

Circuits: 2~16P&20P
 Insulator: High Temperature Plastic UL94V-0
 Color: Natural
 Contact: Phosphor Bronze, Tin-Plated
 Plating: Tin /lead-plated
 Temperature Range: -40°C~+105°C

Poles	Dimension mm (in.)		Part No.	Note.
	A	B		
2	1.0(0.039)	4.0(0.157)	SH-VR-02	
3	2.0(0.079)	5.0(0.197)	SH-VR-03	
4	3.0(0.118)	6.0(0.236)	SH-VR-04	
5	4.0(0.157)	7.0(0.276)	SH-VR-05	
6	5.0(0.197)	8.0(0.315)	SH-VR-06	
7	6.0(0.236)	9.0(0.354)	SH-VR-07	
8	7.0(0.276)	10.0(0.394)	SH-VR-08	
9	8.0(0.315)	11.0(0.433)	SH-VR-09	
10	9.0(0.354)	12.0(0.472)	SH-VR-10	
11	10.0(0.394)	13.0(0.512)	SH-VR-11	
12	11.0(0.433)	14.0(0.551)	SH-VR-12	
13	12.0(0.472)	15.0(0.591)	SH-VR-13	
14	13.0(0.512)	16.0(0.630)	SH-VR-14	
15	14.0(0.551)	17.0(0.669)	SH-VR-15	
16	15.0(0.590)	18.0(0.708)	SH-VR-16	
20	19.0(0.748)	22.0(0.866)	SH-VR-20	

RoHS Compliant

TOLERANCES ARE

MORETHANALL
 PCB CONNECTORS
 Cable ASSEMBLIES

煜倫股份有限公司

www.morethanall.com

DRAWING BY CY

CHECKED BY GENIUS

UNIT / mm

SCALE 1 : 1

DATE

SIZE A4

PJECTION

X, ±
 X, ±
 .XX ±
 .XXX ±
 ANG ±

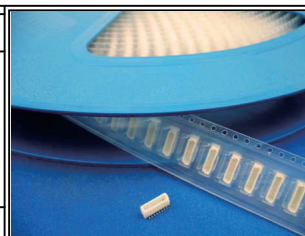

ORDER INFORMATION

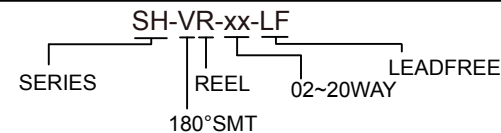

DESCRIPTION: 1.0mm Wire-to-Board Wafer SMT Top Entry

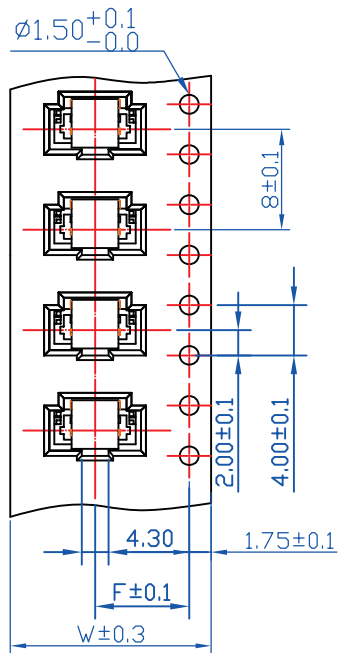

2~13P Contacts

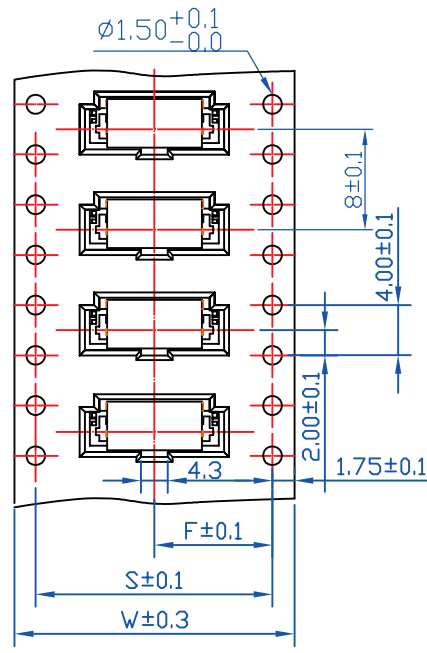

14~16P&20P Contacts

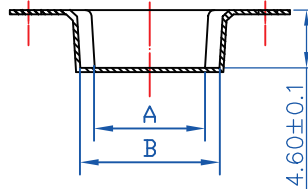
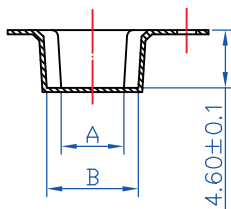
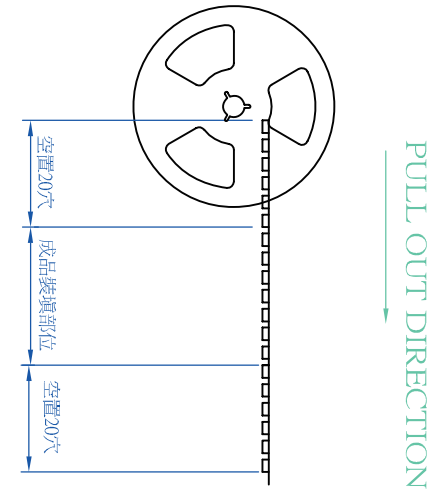

$A = 1.0 \times \text{Poles}$

$B = (1.0 \times \text{Poles}) + 2.3 \text{mm}$

Poles	W	F	S	Q'TY/Reel
02	16.0	7.5	28.4	1000PCS
03	16.0	7.5		1000PCS
04	16.0	7.5		1000PCS
05	16.0	7.5		1000PCS
06	24.0	11.5		1000PCS
07	24.0	11.5		1000PCS
08	24.0	11.5		1000PCS
09	24.0	11.5		1000PCS
10	24.0	11.5		1000PCS
11	24.0	11.5		1000PCS
12	24.0	11.5		1000PCS
13	24.0	11.5		1000PCS
14	32.0	14.2		28.4
15	32.0	14.2	28.4	1000PCS
16	32.0	14.2	28.4	1000PCS
20	44.0	20.2	40.4	1000PCS

RoHS Compliant

TOLERANCES ARE

MORETHANALL
PCB CONNECTORS
Cable ASSEMBLIES

DRAWING BY CY

CHECKED BY GENIUS

UNIT/mm

SCALE 1:1

DATE

SIZE A4

X. ±
.X ±
.XX ±
.XXX ±
ANG ±

PJECTION

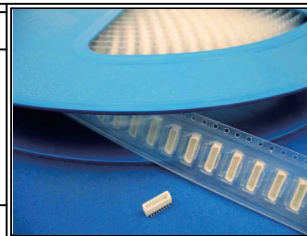

ORDER INFORMATION

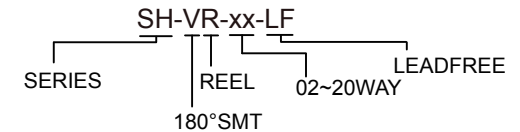

DESCRIPTION: 1.0mm Wire-to-Board Wafer SMT Top Entry

煜倫股份有限公司

www.morethanall.com