

NOTES :
 1.Material :
 Housing : High temperature thermoplastic,UL94-V0.
 Color : Black
 HDMI Terminal : Copper Alloy,
 Cover : Copper Alloy.
 2.Finish :
 Terminal : Underplate : Ni 50 μ" MIN. over all.
 Sn2"100 MIN Solder tail μ"Sn100 MIN Lead free over Ni plate.
 Contact arer: Au over Ni plate
 Cover : Underplate :50 μ" MIN. Ni over all.
 over Ni .
 3.Coplanarity Must Be Within 0.12 Max.

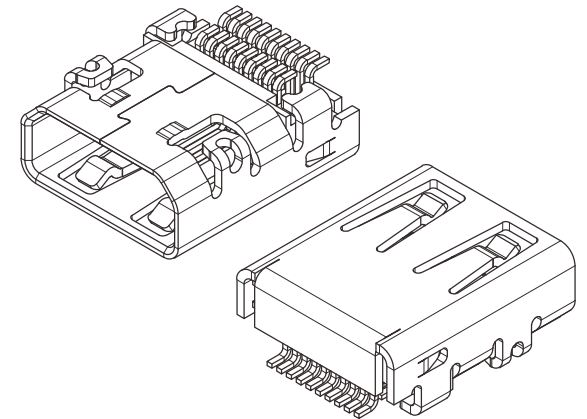

RoHS Compliant

TOLERANCES ARE

MORETHANALL
 PCB CONNECTORS
 Cable ASSEMBLIES

DRAWING BY CY

X. ±

CHECKED BY GENIUS

.X ±

UNIT / mm

SCALE 1 : 1

.XX ±

DATE

.XXX ±

ANG ±

SIZE A4

PJECTION

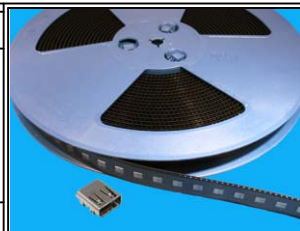

ORDER INFORMATION

MIHDMI-SWJJR-19-LF

SERIES

REEL

JJ TYPE

90°SMT

FEMALE

LEADFREE

19 WAY

煜倫股份有限公司

www.morethanall.com

DESCRIPTION:

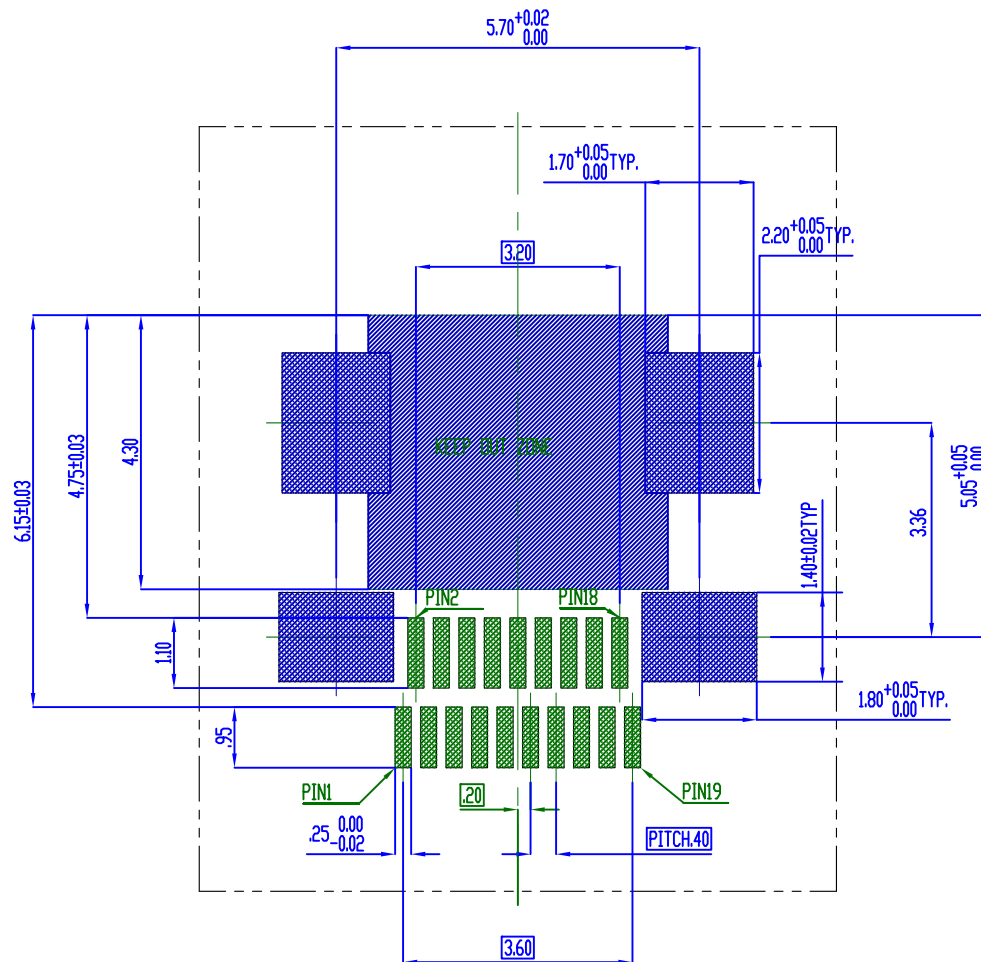

Recommend PCB Layout Tolerance = +/- 0.02 mm



HDMI Each Signal Terminal
Will Be Functional After Detected.

19	5V Power
18	SDA
17	SCL
16	DDC/CEC Ground
15	CEC
14	TMDS Clock-
13	TMDS Clock Shield
12	TMDS Clock+
11	TMDS Data0-
10	TMDS Data0 Shield
09	TMDS Data0+
08	TMDS Data1-
07	TMDS Data1 Shield
06	TMDS Data1+
05	TMDS Data2-
04	TMDS Data2 Shield
03	TMDS Data2+
02	Utility
01	Hot Plug Detect
Pin NO.	Description
Pin Assignment	

RoHS Compliant

TOLERANCES ARE

MORETHANALL
PCB CONNECTORS
Cable ASSEMBLIES

DRAWING BY CY

X. ±

CHECKED BY GENIUS

.X ±

UNIT / mm

SCALE 1 : 1

.XX ±

DATE

.XXX ±

ANG ±

SIZE A4

P PROJECTION

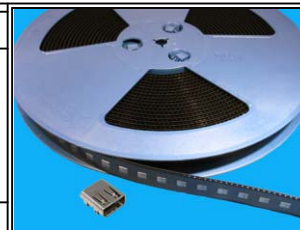

ORDER INFORMATION

MIHDMI-SWJJR-19-LF

SERIES

LEADFREE

19 WAY

REEL

JJ TYPE

90°SMT

FEMALE

煜倫股份有限公司

www.morethanall.com

DESCRIPTION:

1. Tape Packed Status

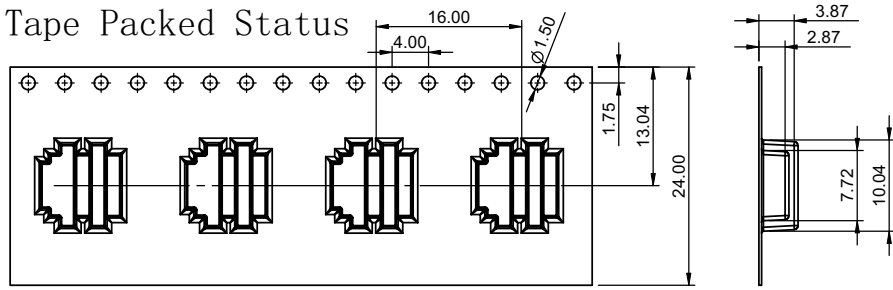

3. Carton Containing 8 Reel (See Chart A)

	Packing Quality	
	Reel	Carton
A	1000	8000

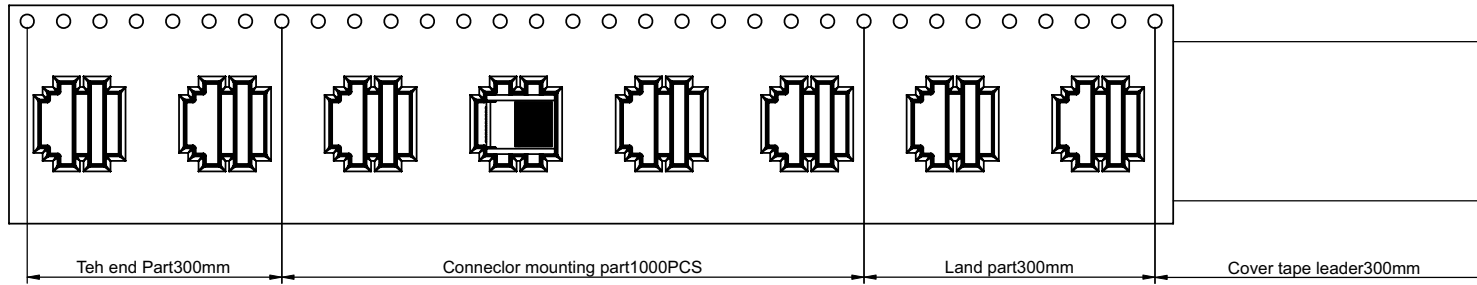
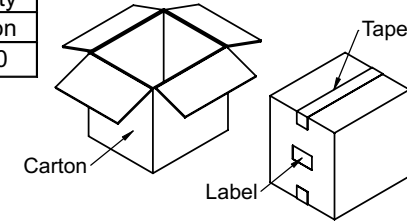

2. Reel Packed Status

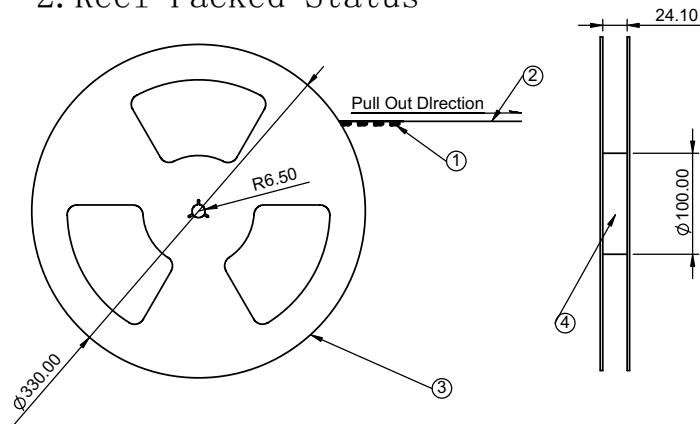

ITEM	NAME	MATERIAL	COLOR
1	CARRIER TAPE	PS	BLACK
2	COVER	PE	TRANSLUCENT
3	REEL PLATE	PS	BLUE
4	REEL CORE	PS	BLUE

RoHS Compliant

TOLERANCES ARE

MORETHANALL
PCB CONNECTORS
Cable ASSEMBLIES

DRAWING BY CY

X, ±

CHECKED BY GENIUS

.X ±

UNIT / mm

SCALE 1 : 1

.XX ±

DATE

.XXX ±

ANG ±

SIZE A4

PJECTION

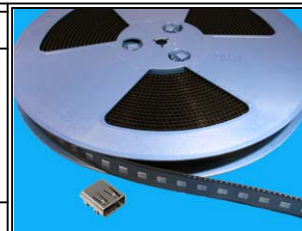

ORDER INFORMATION

MIHDMI-SWJJR-19-LF

SERIES

REEL

JJ TYPE

90°SMT

FEMALE

LEADFREE

19 WAY

煜倫股份有限公司

www.morethanall.com

DESCRIPTION: