

SEC: A-A

NOTES:  
 SPECIFICATION:  
 CONTACT CURRENT RATING: 0.5 AMPERES.  
 DIELECTRIC WITHSTANDING VOLTAGE: AC 300V R.M.S.  
 INSULATION RESISTANCE: 100MΩ MIN.  
 CONTACT RESISTANCE: 30 mΩ MAX.  
 ENVIRONMENTAL:  
 OPERATING TEMPERATURE: -20°C~+85°C.  
 MATERIAL:  
 INSULATOR: HI-TEMP PLASTIC UL 94V-0.  
 CONTACT: COPPER ALLOY T=0.20mm.  
 SHELL: COPPER ALLOY T=0.50mm.

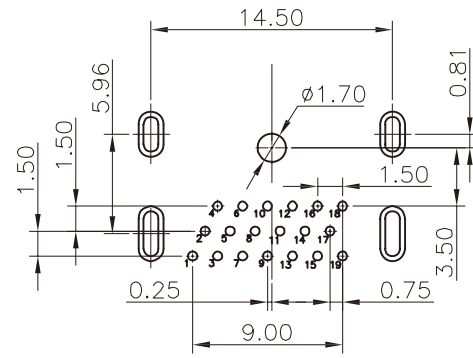

RECOMMENDED P.C BOARD LAYOUT

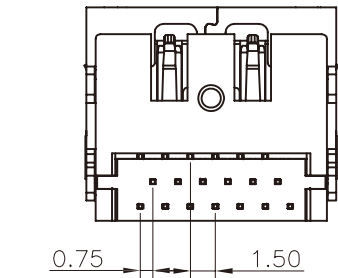
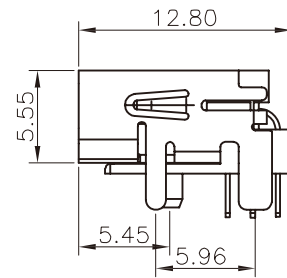
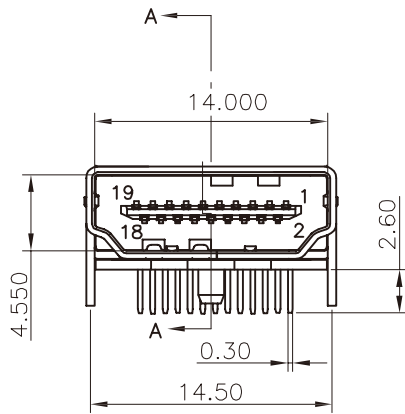
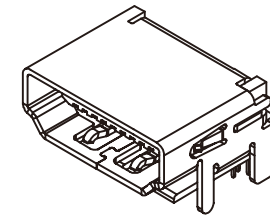

UNLESS OTHERWISE SPECIFIED, TOLERANCE ON DECIMAL: ±0.2

RoHS Compliant



煜倫股份有限公司

www.morethanall.com

DRAWING BY CY	
CHECKED BY GENIUS	
UNIT/mm	SCALE 1:1
DATE	
SIZE A4	PJECTION

TOLERANCES ARE
X, ±
.X ±
.XX ±
.XXX ±
ANG ±

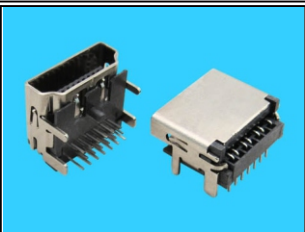

ORDER INFORMATION

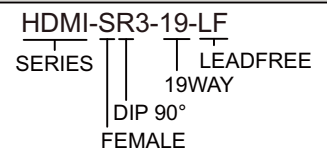

DESCRIPTION: HDMI 19PIN FEMALE