

NOTES :

- 1.0. RATING :
 - 1.1. VOLTAGE : 30 VAC (R.M.S.)
 - 1.2. CURREN : 1.5 AMPERE MAXIMUM PER CONTACT AT 30°C T-RISE
 - 1.3. TEMPERATURE RANGE :
 - STORAGE:-20°C TO +60°C
 - OPERATING:0°C TO +50°C
- 2.0. ELECTRIC CHARACTERISTIC :
 - 2.1. CONTACT RESISTANCE : 30 MILLIOHMS MAXIMUM INITIAL
 - 2.2. INSULATION RESISTANCE : 1,000 MEGOHMS MINIMUM
 - 2.3. DIELECTRIC WITHSTANDING VOLTAGE : 750 VAC AT SEE LEVER
- 3.0. MATERIALS :
 - 3.1. UPPER & LOWER SHELL : STEEL
 - 3.2. HOUSING : THERMPLASTC, GLASS FILLED, UL 94V-0 RATED
 - 3.3. CONTACT : COPPER ALLOY
- 4.0. FINISHS :
- 5.0. OTHERS :
 - 5.1. RECOMMENDED CABLE APPLICATION :
 - OUTTER DIAMETER APPLICABLE RANGE : ϕ 3.4mm TO ϕ 5.3mm
 - 5.2. ALL PARTS PACKAGED UNASSEMBLED
 - 5.3. PRODUCT NUMBERING CODE: REFER TO TABLE A

3	HOUSING	1	SEE NOTE 3.2.
2	LOWER SHELL	1	SEE NOTE 3.1.
1	UPPER SHELL	1	SEE NOTE 3.1.; 4.1.
ITEM	NAME	Q'TY	MATERIAL / FINISH

RoHS Compliant

TOLERANCES ARE

MORETHANALL
PCB CONNECTORS
Cable ASSEMBLIES

煜倫股份有限公司

www.morethanall.com

DRAWING BY CY

X. \pm

CHECKED BY GENIUS

.X \pm

UNIT / mm

SCALE 1 : 1

.XX \pm

DATE

.XXX \pm

ANG \pm

SIZE A4

PPOJECTION

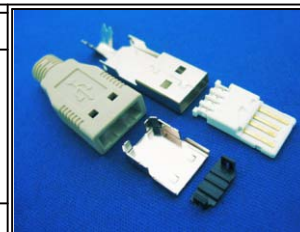

ORDER INFORMATION

USB-PAWHxx-4A-LF
SERIES | | | LEADFREE
4 PIN A TYPE
MALE | | 40:4.0mm OUTLET
ASSEMBLY | | 47:4.7mm OUTLET
55:5.5mm OUTLET
WHITE

DESCRIPTION:

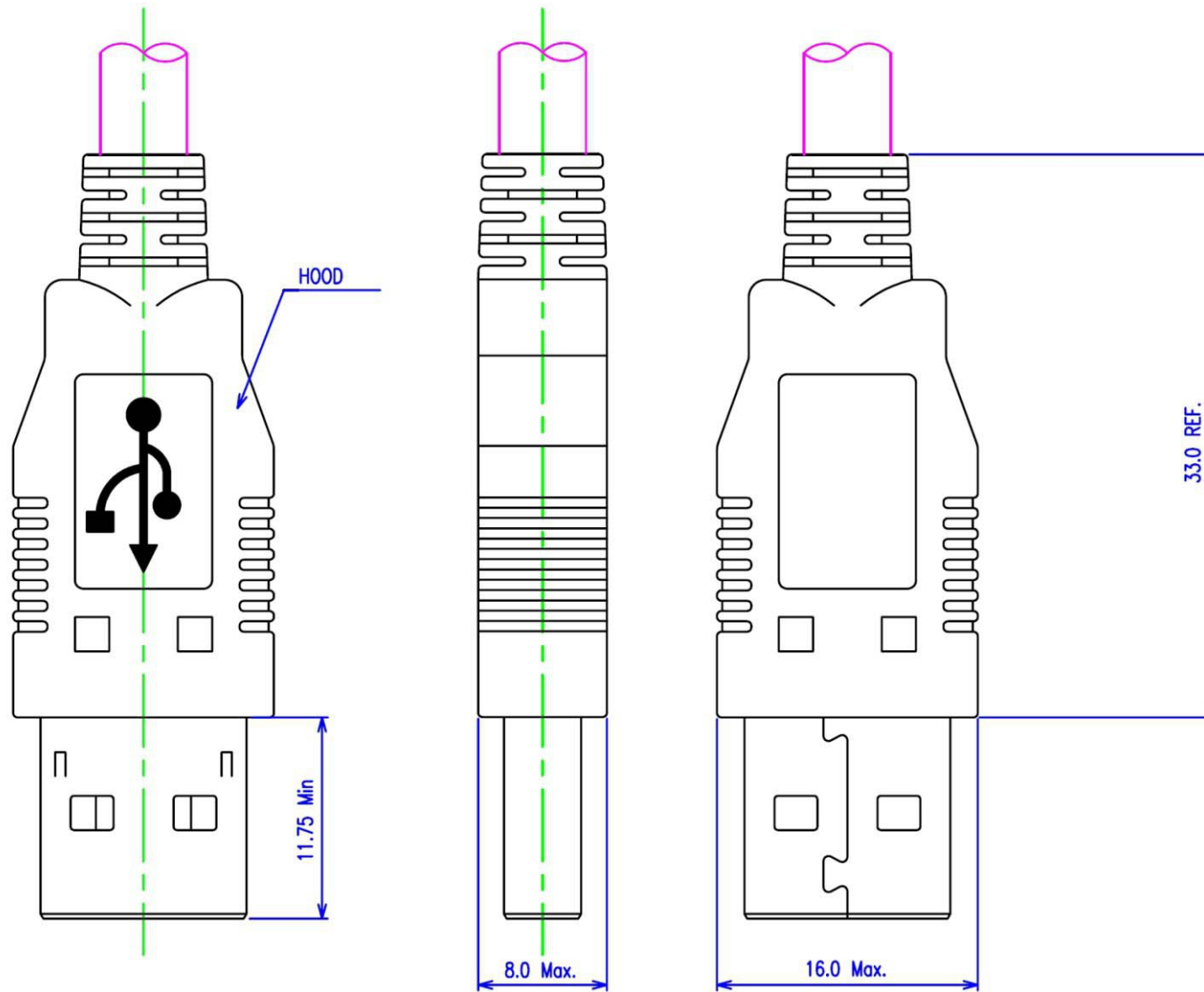

RECOMMENDED OVERMOLD DIMENSION

RoHS Compliant

TOLERANCES ARE

MORETHANALL
PCB CONNECTORS
Cable ASSEMBLIES

DRAWING BY CY

X. ±

CHECKED BY GENIUS

.X ±

UNIT / mm

SCALE 1 : 1

.XX ±

DATE

.XXX ±

ANG ±

煜倫股份有限公司

www.morethanall.com

SIZE A4

PJECTION

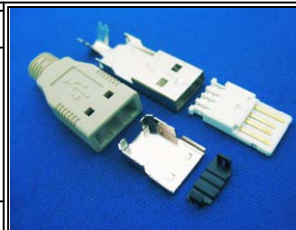

ORDER INFORMATION

USB-PAWHxx-4A-LF

SERIES	LEADFREE
MALE	4 PIN A TYPE
ASSEMBLY	40:4.0mm OUTLET
	47:4.7mm OUTLET
	55:5.5mm OUTLET
	WHITE

DESCRIPTION:

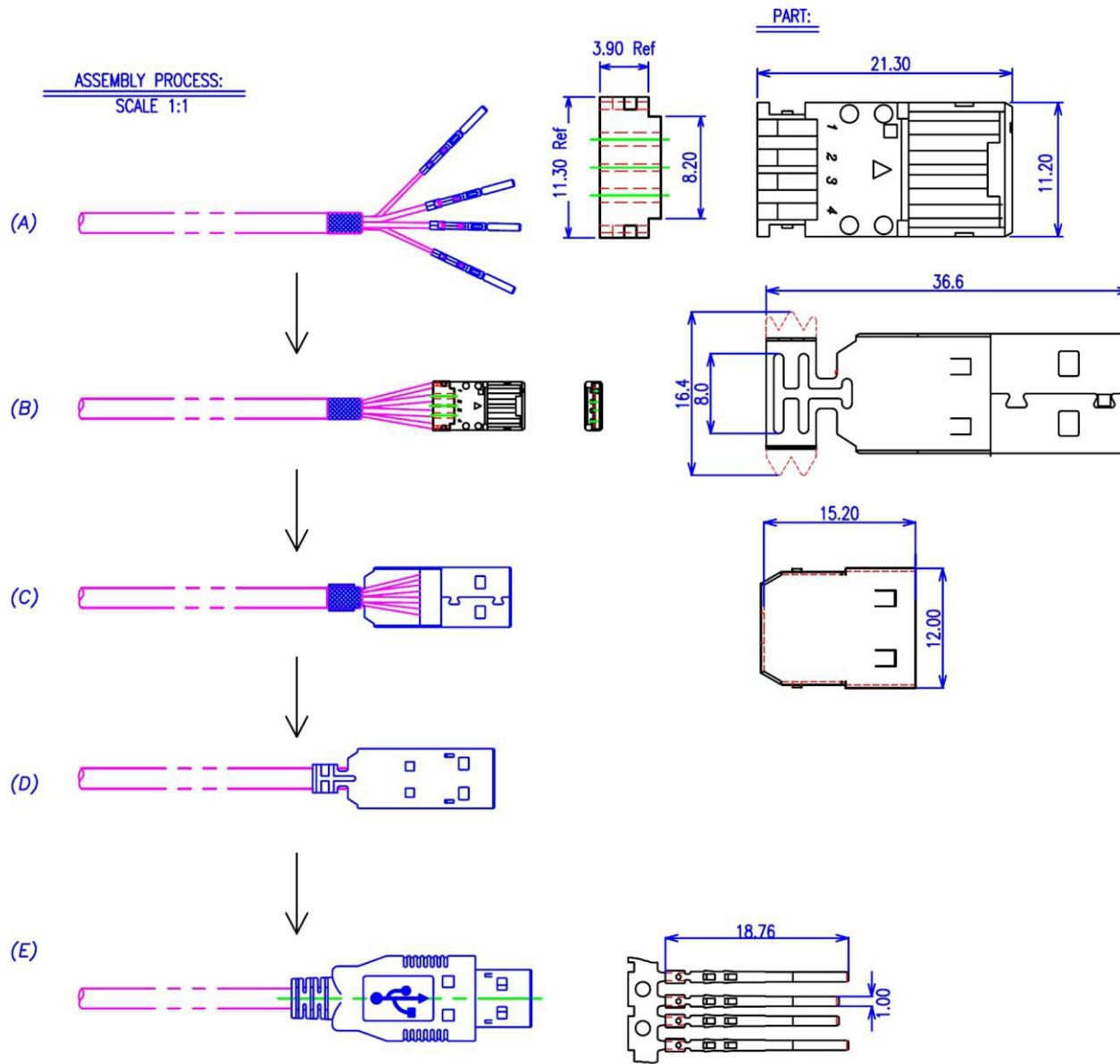

RoHS Compliant

TOLERANCES ARE

MORETHANALL
PCB CONNECTORS
Cable ASSEMBLIES

DRAWING BY CY

X, ±

CHECKED BY GENIUS

.X ±

UNIT / mm

SCALE 1:1

.XX ±

.XXX ±

ANG ±

DATE

SIZE A4

PPOJECTION

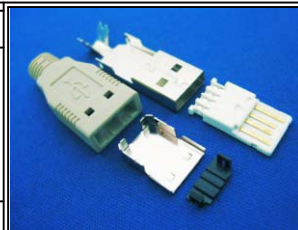

ORDER INFORMATION

USB-PAWHxx-4A-LF

SERIES	LEADFREE
MALE	4 PIN A TYPE
ASSEMBLY	40:4.0mm OUTLET
	47:4.7mm OUTLET
	55:5.5mm OUTLET
	WHITE

煜倫股份有限公司

www.morethanall.com

DESCRIPTION:

VIEW A

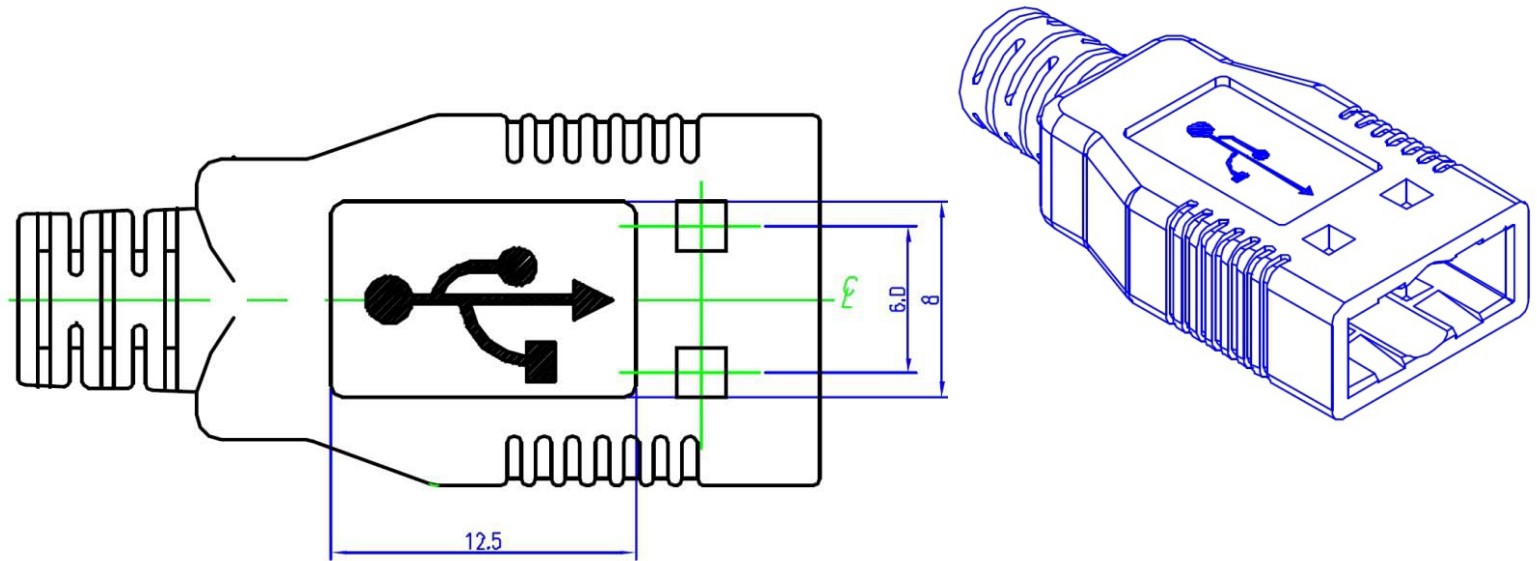

CABLE EXIT: TYPE I
(RECOMMENDED CABLE OD=φ3.4~φ3.8)

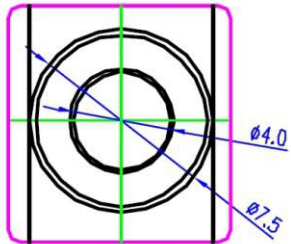

CABLE EXIT: TYPE II
(RECOMMENDED CABLE OD=φ3.9~φ4.6)

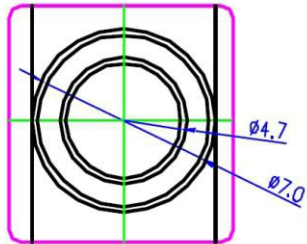

CABLE EXIT: TYPE III
(RECOMMENDED CABLE OD=φ4.7~φ5.3)

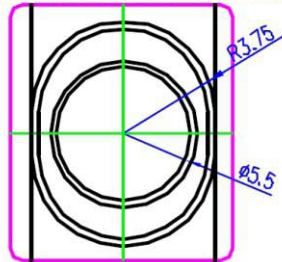

△CABLE EXIT: TYPE IV
(RECOMMENDED CABLE OD=φ4.5~φ4.9)

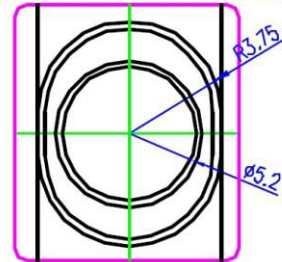

RoHS Compliant

TOLERANCES ARE

MORETHANALL
PCB CONNECTORS
Cable ASSEMBLIES
煜倫股份有限公司

DRAWING BY CY
CHECKED BY GENIUS
UNIT / mm SCALE 1 : 1
DATE

X, ±
.X ±
.XX ±
.XXX ±
ANG ±

SIZE A4

PPOJECTION

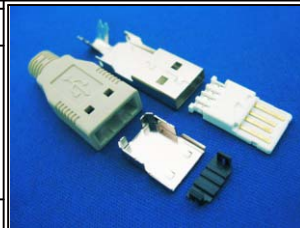

ORDER INFORMATION

USB-PAWHxx-4A-LF
SERIES | | | LEADFREE
4 PIN A TYPE
MALE | 40:4.0mm OUTLET
ASSEMBLY | 47:4.7mm OUTLET
55:5.5mm OUTLET
WHITE

DESCRIPTION:

www.morethanall.com