

NOTES:
 1.MATERIAL: P.P.
 2.COLOR: BLACK

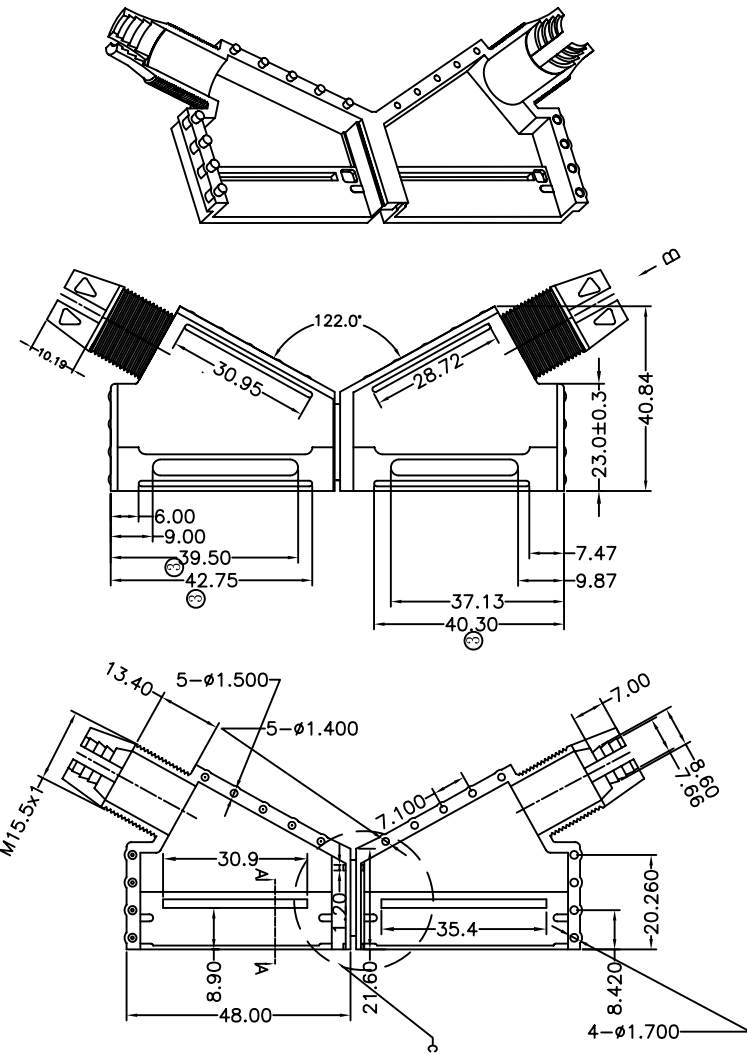

NOTES:
 1. MATERIAL: P.P.

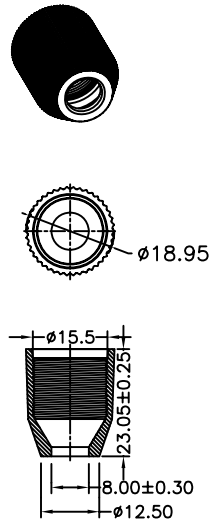

NOTES
 1.MATERIAL:STAINLESS 430# 0.4t.

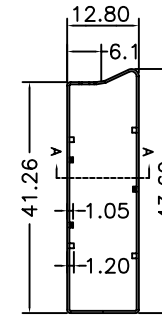

Insulator
 1.P.C.
 2.P.B.T.

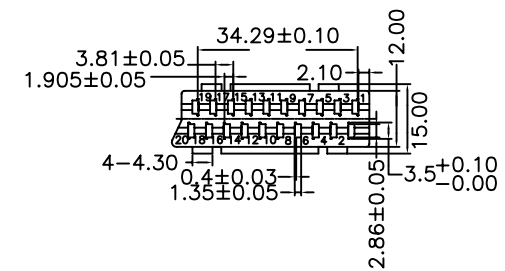
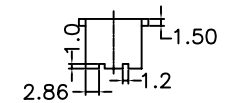
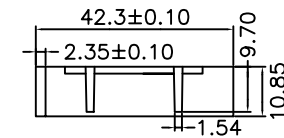
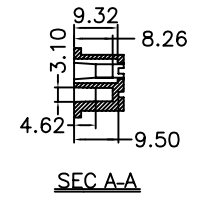
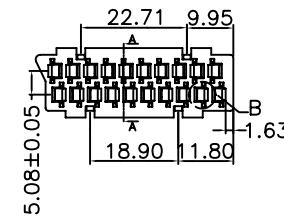
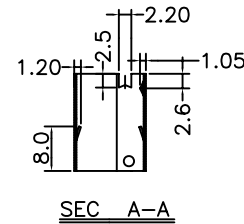
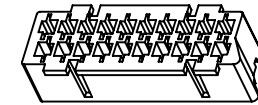

RoHS Compliant

TOLERANCES ARE

MORETHANALL
 PCB CONNECTORS
 Cable ASSEMBLIES

DRAWING BY CY
 CHECKED BY GENIUS
 UNIT / mm SCALE 1 : 1
 DATE

X. ±
 .X ±
 .XX ±
 .XXX ±
 ANG ±

煜倫股份有限公司

www.morethanall.com

SIZE A4 PPROJECTION



ORDER INFORMATION

SC-PA-21-LF
 SERIES | LEADFREE
 | 21 WAY
 | ASSEMBLY
 MALE

DESCRIPTION: