

MATERIALS

HOUSING: LCP (UL 94V-0), BLACK
 SHELL: STAINLESS STEEL
 PAD: STAINLESS STEEL, GOLD FLASH
 TERMINAL: PHOSPHOR BRONZE, GOLD PLATED ON CONTACT AREA, TIN PLATING ON SOLDER TAIL

SPECIFICATION

CURRENT RATING: 0.5AMP MAX
 DIELECTRIC WITHSTANDING: 500V AC FOR ONE MINUTE
 CONTACT RESISTANCE: 100m OHMS MAX
 INSULATION RESISTANCE: 1000M OHMS AT DC 500V
 OPERATION TEMPERATURE: -25°C~+85°C
 COPLANARITY OF SOLDER TAILS: 0.10mm MAX

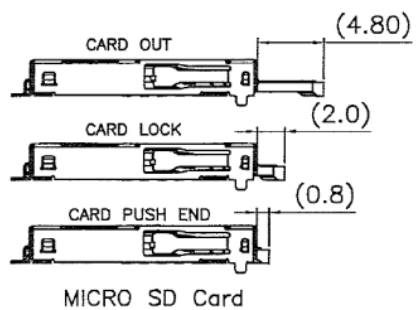

SIM CARD EJECT AREA

RoHS Compliant

TOLERANCES ARE



DRAWING BY CY

CHECKED BY GENIUS

UNIT / mm

SCALE 1 : 1

DATE

SIZE A4

X, ±
 X ± 0.30
 .XX ± 0.20
 .XXX ± 0.10
 ANG ±

PJECTION

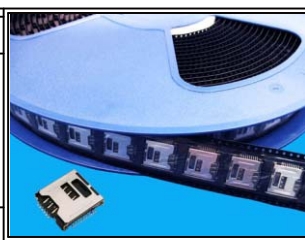

ORDER INFORMATION

SCTF-W17TR-0608-LF
 SERIES | REEL | LEADFREE
 | 17.05mm TAB | 06 TO 08 WAY
 90°SMT

DESCRIPTION: TFLASH+SIM CARD

煜倫股份有限公司

www.morethanall.com

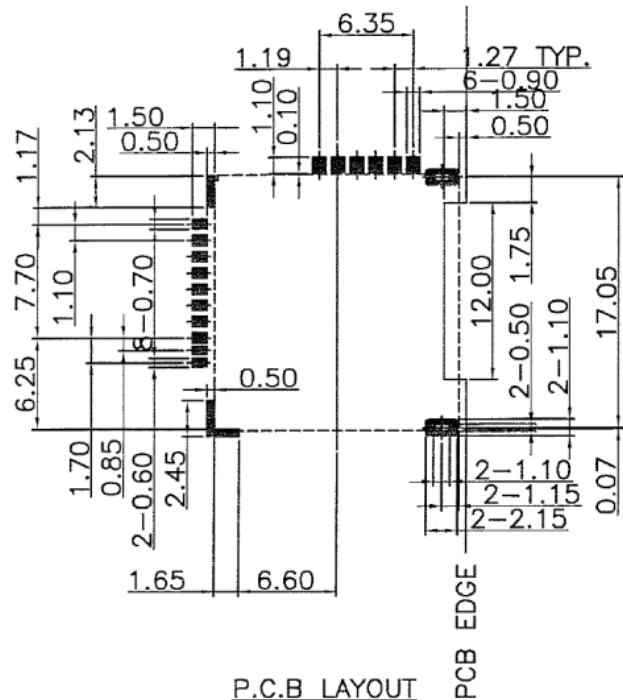

P.C.B LAYOUT
TOP VIEW ±0.05

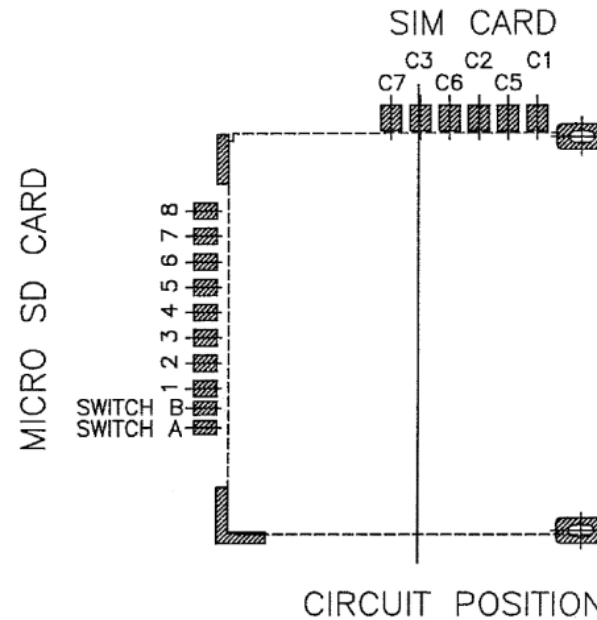

CIRCUIT POSITION

SIM CARD	
Pin No.	NAME
C1	VCC
C2	RST
C3	CLK
C4	Reserved
C5	GND
C6	VPP
C7	I/O
C8	Reserved

MICRO SD CARD			
Pin No.	NAME	TYPE	DESCRIPTION
1	DAT2	I/O/PP	Date Line[bit2]
2	CD/DAT3	I/O/PP	Card Detect Date Line[bit3]
3	CMD	PP	Command Response
4	VDD	S	Supply Voltage
5	CLK	I	Clock
6	VSS	S	Supply Voltage Ground
7	DAT0	I/O/PP	Date Line[bit0]
8	DAT1	I/O/PP	Date Line[bit1]

INFORMATION

1.SWITCH TYPE: CARD OUT—SWITCH OPEN
CARD IN—SWITCH CONTACT

RoHS Compliant

TOLERANCES ARE

MORETHANALL
PCB CONNECTORS
Cable ASSEMBLIES

煜倫股份有限公司

www.morethanall.com

DRAWING BY CY

CHECKED BY GENIUS

UNIT / mm SCALE 1 : 1

DATE

SIZE A4

X, ±
.X ±
.XX ±
.XXX ±
ANG ±

P PROJECTION

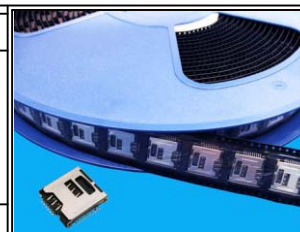

ORDER INFORMATION

SCTF-W17TR-0608-LF

SERIES | | | LEADFREE
06 TO 08 WAY
REEL
17.05mm TAB
90°SMT

DESCRIPTION: TFLASH+SIM CARD

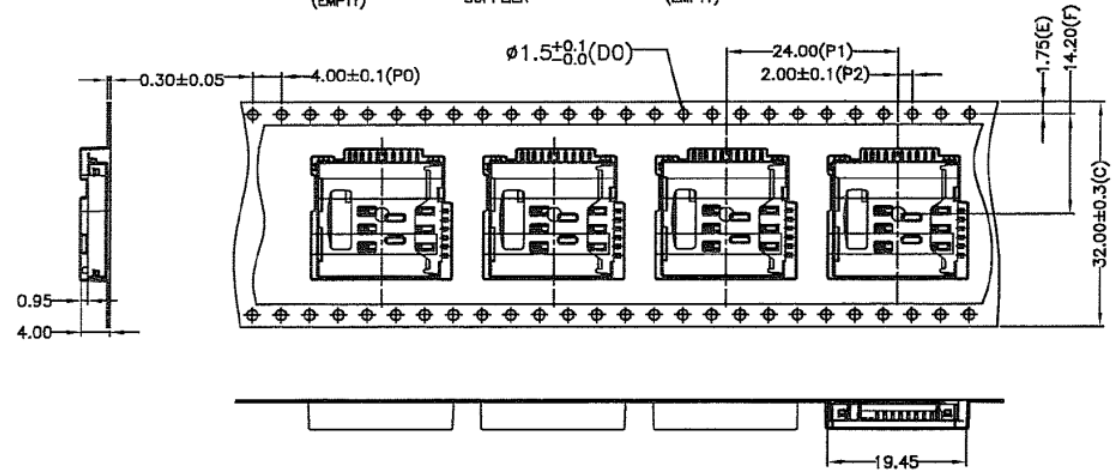
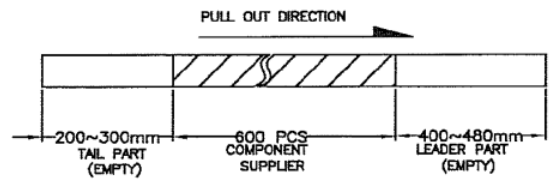
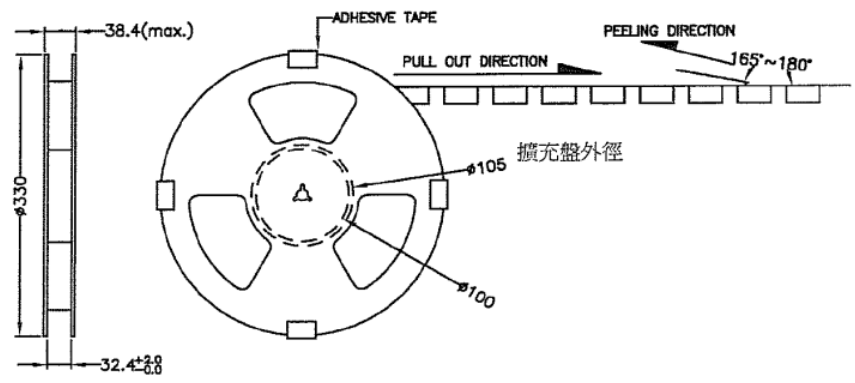

NOTES:

- 1.包裝數量(NUMBER OF CONNECTORS):
600PCS/REEL
- 2.引導帶長度(LEAD TAPE LENGTH)

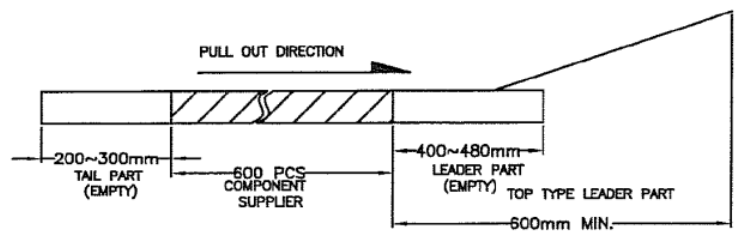

- 3.上帶剝離強度(PEELING OFF FORCE OF TOP TAPE)
0.1N~1.3N
剝離方向以下圖為參照(PEELING DIRECTION AS SHOWN IN FOLLOWING FIG)

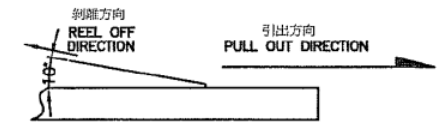

- 4.材料(MATERIAL).
載帶(CARRIER TYPE):PS(POLYSTYRENE.)
上帶(TOP TYPE):PE
卷輪(REEL):PS(POLYSTYRENE)
擴充盤(EXPAND COIL):STEEL COTTON(330*32*6mm)

RoHS Compliant

TOLERANCES ARE

MORETHANALL
PCB CONNECTORS
Cable ASSEMBLIES
煜倫股份有限公司
www.morethanall.com

DRAWING BY CY		X ± 0.30 X ± 0.30 .XX ± 0.20 .XXX ± 0.10 ANG ± 1°
CHECKED BY GENIUS		
UNIT / mm	SCALE 1 : 1	
DATE		
SIZE A4	P PROJECTION	

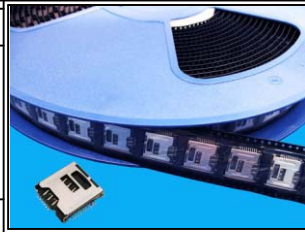

ORDER INFORMATION

SCTF-W17TR-0608-LF			
SERIES		LEADFREE	
		06 TO 08 WAY	
		REEL	
		17.05mm TAB	
		90°SMT	

DESCRIPTION: TFLASH+SIM CARD

TOTAL
5 LAYERS

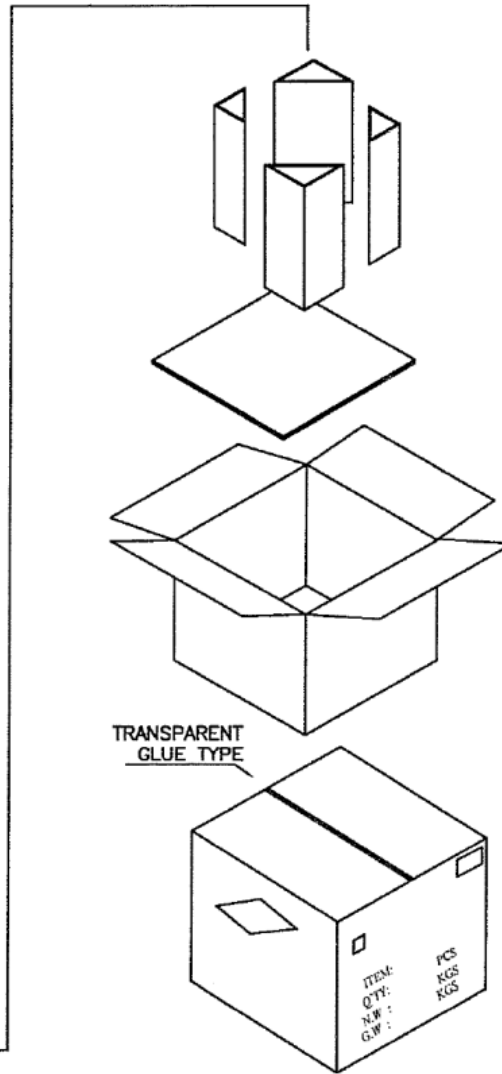
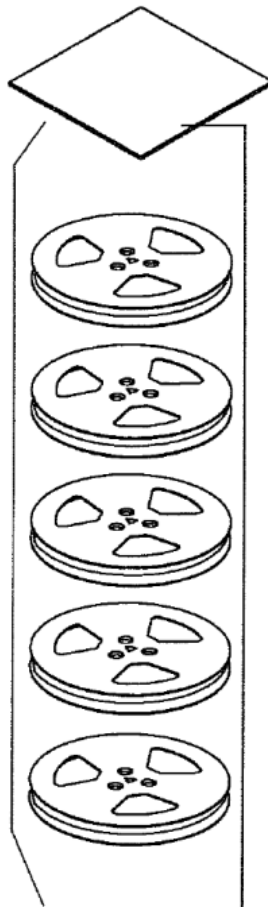

包裝數量(NUMBER OF CONNECTORS):
600PCS/REEL
5REELS/BAG
1BAG/BOX
3000PCS/BOX

RoHS Compliant

TOLERANCES ARE

MORETHANALL
PCB CONNECTORS
Cable ASSEMBLIES

煜倫股份有限公司

www.morethanall.com

DRAWING BY CY

CHECKED BY GENIUS

UNIT / mm

SCALE 1 : 1

DATE

SIZE A4

X, ±

.X ±

.XX ±

.XXX ±

ANG ±

PJECTION

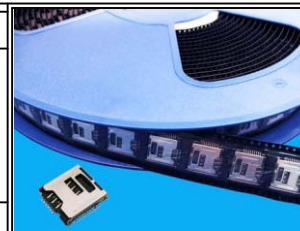

ORDER INFORMATION

SCTF-W17TR-0608-LF

SERIES | | LEADFREE
| | 06 TO 08 WAY
| | REEL
| | 17.05mm TAB
| | 90°SMT

DESCRIPTION: TFLASH+SIM CARD