

RECOMMENDED P.C.B. LAYOUT
TOLERANCE UNSPECIFIED $\pm 0.05\text{mm}$

5	SHELL	STAINLESS STEEL	NI/SN Plated	1PCS
4	SPRING	STAINLESS STEEL	---	1PCS
3	SHIELDING PLATE	STAINLESS STEEL	NI Plated	1PCS
2	CONTACT	COPPER ALLOY	Au/NI Plated	1SET
1	HOUSING	HIGH TEMPERATURE PLASTIC	BLACK	1PCS
NO.	DESCRIPTION	MATERIAL	REMARKS	QTY

A1	GND	B12	GND
A2	SSTXP1	B11	SSRXP1
A3	SSTXN1	B10	SSRXN1
A4	VBUS	B9	VBUS
A5	CC1	B8	SBU2
A6	DP1	B7	DN2
A7	DN1	B6	DP2
A8	SBU1	B5	CC2
A9	VBUS	B4	VBUS
A10	SSRXN2	B3	SSTXN2
A11	SSRXP2	B2	SSTXP2
A12	GND	B1	GND
PIN	SIGNAL NAME	PIN	SIGNAL NAME

NOTES:

SPECIFICATION:

1. CURRENT RATING: 3A MAX
2. VOLTAGE: 100 VAC
3. TEMPERATURE RANGE: $-30\text{ }^{\circ}\text{C} \sim 85\text{ }^{\circ}\text{C}$
4. CONTACT RESISTANCE: 40 MILLIONHM MAX
5. INSULATION RESISTANCE: 100 MEGOHMS MIN.
6. LNSERTION FORCE : 5N~20N
7. UNMATING FORCE: 8N~20N
8. DURABILITY: 10,000 CYCLES

RoHS Compliant

TOLERANCES ARE

MORETHANALL
PCB CONNECTORS
Cable ASSEMBLIES

DRAWING BY CY

X. ± 0.50

CHECKED BY GENIUS

.X ± 0.30

UNIT / mm

SCALE 1 : 1

.XX ± 0.20

DATE

.XXX ± 0.10

ANG \pm

SIZE A4

PJECTION

照片框

ORDER INFORMATION

USB-SWMP8668MMR-24C-LF
SERIES | LEADFREE
FEMALE | 24 PIN C TYPE
90°SMT | REEL
METAL PIN
METAL FOOT & POST 8.64x6.80mm

DESCRIPTION: USB C F TYPE 双排 SMT 四脚插板 有柱 CONN

煜倫股份有限公司

www.morethanall.com

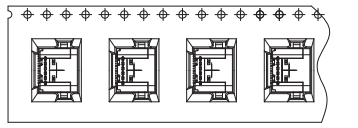

USB C F TYPE 沉板0.8 CONN

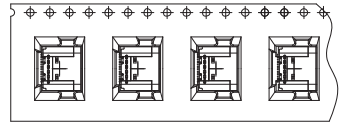

USB C F TYPE 双排SMT 四脚插板

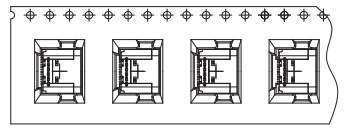

USB C F TYPE 双排SMT 四脚插板 有柱

① 产品入载带示意图

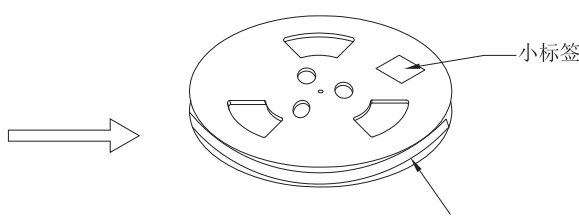

② 卷盘贴标签示意图

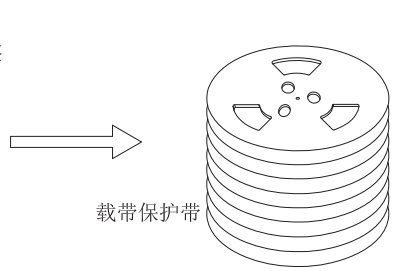

③ 10盘产品叠层示意图

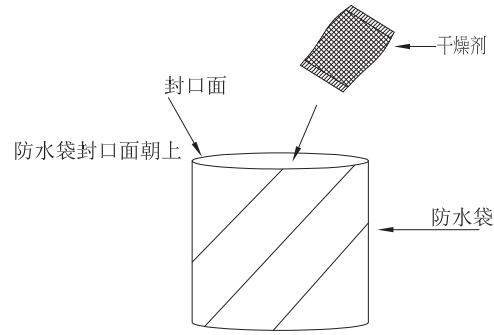

④ 10盘产品入防水袋示意图

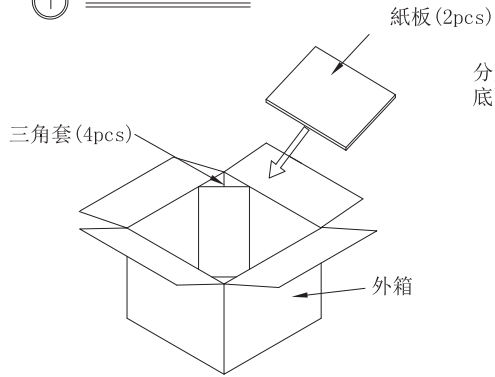

⑤ 产品入外箱示意图

分别放在外箱底面和最上面

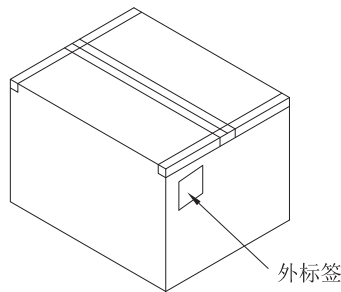

⑥ 外箱封箱示意图

NOTE:

- 1. QUANTITY/REEL: 900 PCS
数量/卷: 900 PCS
- QUANTITY/INNER CARTON: 900 X 10 = 9000 PCS
数量/箱: 900 X 10 = 9000 PCS
- 2. FREE 27 CAVE IN THE FRONT CARRIER AND FREE 27 CAVE IN THE END CARRIER.
包装带内圈空27格, 外圈空27格.

1	成品		C TYPE母座成品	900
2	CARRIER TAPE	PET	W=24mm T=0.35mm	15.26M
3	COVER TAPE	PET	W=13.3mm T=0.05mm	16.26M
4	小标签		L102mm*W59mm	10
5	卷盘	PS	φ330MM*W28.5MM	10
6	天地板	K3K	L380mm*W380mm	2
7	外标签		L102mm*W102mm	1
8	三角柱	K=K	L300mm*W210mm	4
9	外箱	A=A	L400mm*W400mm*33.5mm	1
10	防水袋	PS	L900mm*W800mm	1
11	干燥剂			1
ITEM	DESC.	MATERIAL	REMARKS	QTY

RoHS Compliant

TOLERANCES ARE



煜倫股份有限公司

www.morethanall.com

DRAWING BY CY
CHECKED BY GENIUS
UNIT / mm SCALE 1 : 1
DATE
SIZE A4 PPROJECTION

X. ± 0.50
.X ± 0.30
.XX ± 0.20
.XXX ± 0.10
ANG ±

照片框

ORDER INFORMATION

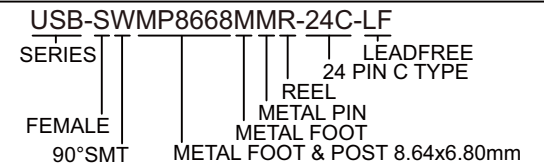

DESCRIPTION: USB C F TYPE 双排SMT 四脚插板 有柱 CONN包規