

△ NOTE :

- 1.0. MATERIALS :
- 1.1. ABS RESIN, UL 94V-0 RATED
- 2.0. OTHER :
- 2.1. ALL PART MUST BE PURCHASED SEPARATELY (REFER TO TABLE B)
- 2.2. PRODUCT NUMBERING CODE: REFER TO TABLE A

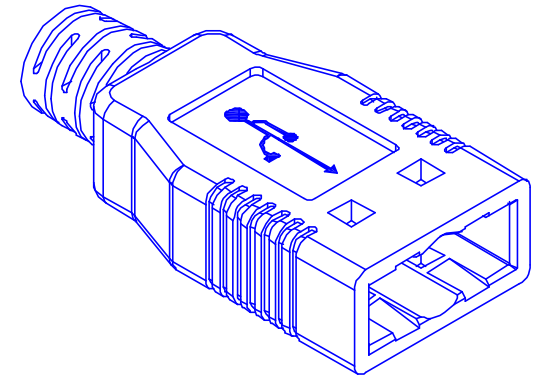

**MORETHANALL**  
CONNECTORS  
ASSEMBLIES

PART NO. **USB-PCxx-4A**

DWG NO. **USB-PCxx-4A**

CHECKED BY CY

TOLERANCES ARE

DESCRIP TION:

FILE NO.

DRAWING BY

.X ± 0.2  
.XX ±  
.XXX ±  
AWG

AREA

REVISIONS

HK

DATE

煜倫股份有限公司

UNIT / mm

SCALE 1:1

PROJECTION

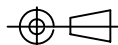

**USB-PCxx-4A-LF**

**OD:**

- 40:4.0  $\phi$
- 47:4.7  $\phi$
- 55:5.5  $\phi$

**LEADFREE**

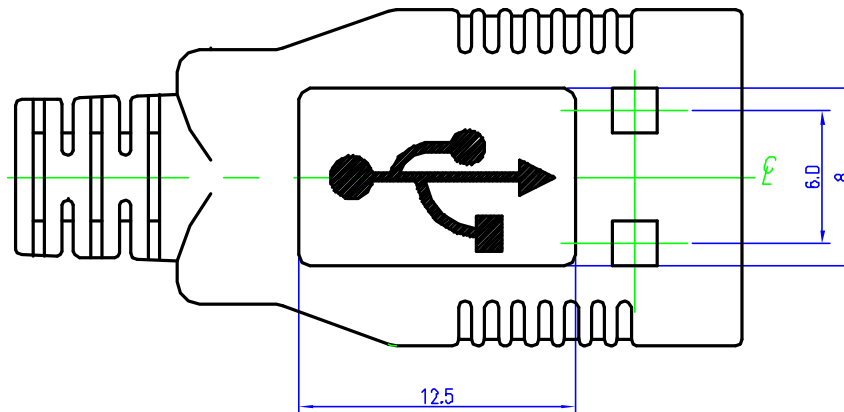

CABLE EXIT: TYPE I  
(RECOMMENDED CABLE OD= $\phi$ 3.4~ $\phi$ 3.8)

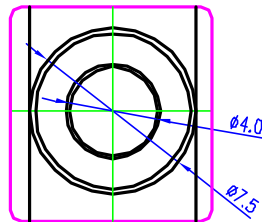

CABLE EXIT: TYPE II  
(RECOMMENDED CABLE OD= $\phi$ 3.9~ $\phi$ 4.6)

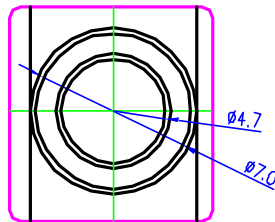

CABLE EXIT: TYPE III  
(RECOMMENDED CABLE OD= $\phi$ 4.7~ $\phi$ 5.3)

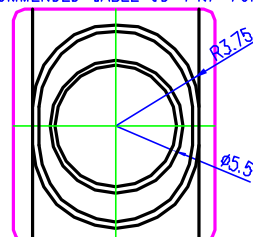

CABLE EXIT: TYPE IV  
(RECOMMENDED CABLE OD= $\phi$ 4.5~ $\phi$ 4.9)

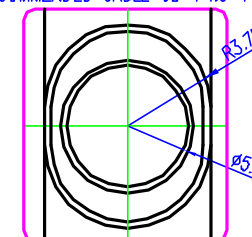

**RoHS Compliant**



PART NO. **USB-PCxx-4A**

DWG NO. **USB-PCxx-4A**

FILE NO.

UNIT / mm

SCALE 1:1

CHECKED BY CY

DRAWING BY

PROJECTION

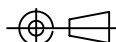

TOLERANCES ARE

- .X  $\pm$  0.2
- .XX  $\pm$
- .XXX  $\pm$
- AWG

DESCRIPTION:

AREA

REVISIONS

HK

DATE

煜倫股份有限公司