

MATING: ① INSERTING(30°) — ② ROTATING — ③ FIXED
 UNMATING: ④ UNFIXED — ⑤ ROTATING — ⑥ WITHDRAWING

NOTES:

1. MATERIAL:

- 1.1 HOUSING: LCP, UL94V-0, COLOR: BLACK.
- 1.2 CONTACT: PHOSPHOR BRONZE.
- 1.3 SOLDER PEG AND LATCH: STAINLESS STEEL.

2. FINISH:

- 2.1 CONTACT: 50μ" MIN NICKEL UNDERPLATED ALL OVER.
GOLD FLASH PLATING ON SOLDER TAIL.
GOLD PLATING (THICKNESS SEE TABLE) ON CONTACT AREA.
- 2.2 SOLDER PEG:
50μ" MIN NICKEL UNDERPLATED ALL OVER.
AU 2μ" MAX ON SOLDER TAIL.

3. DATE CODE : YYWWDLX

YY: YEAR (09: 2009)
 WW: WEEK (25: THE 25TH WEEK)
 D: DAY (1~7: SUNDAY~SATURDAY)
 L: LINE NUMBER OF ASSEMBLY (A: LINE A)
 X: D OR N (D: DAY; N: NIGHT)

RoHS Compliant

TOLERANCES ARE

MORETHANALL
 PCB CONNECTORS
 Cable ASSEMBLIES

DRAWING BY CY

CHECKED BY GENIUS

UNIT / mm

SCALE 1 : 1

DATE

SIZE A4

P PROJECTION

X, ±
 .X ± 0.30
 .XX ± 0.20
 .XXX ±
 ANG ± 3°

照片框

ORDER INFORMATION

SDM5-W92V12R-144116-LF

SERIES

REEL

12V

HIGH 9.2mm

90°SMT

LEADFREE
 144+116 WAY

DESCRIPTION: DDR4 SO DIMM 260P 9.2H STD C-DWG

煜倫股份有限公司

www.morethanall.com

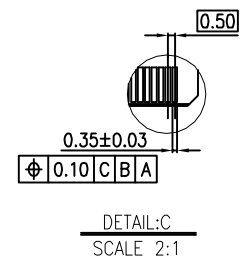
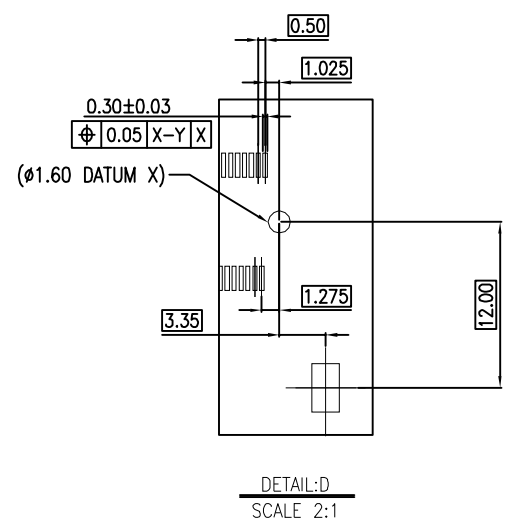
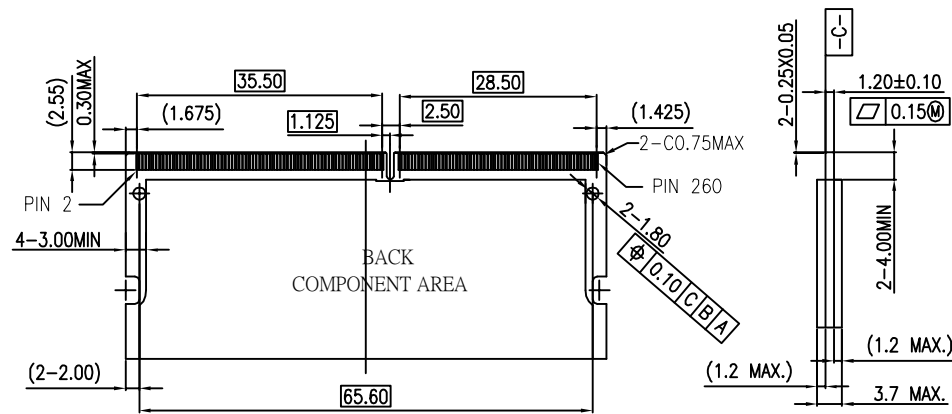
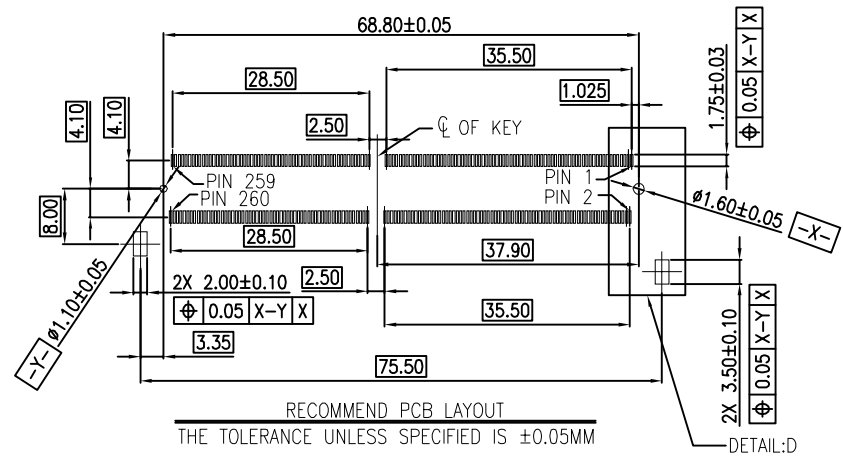
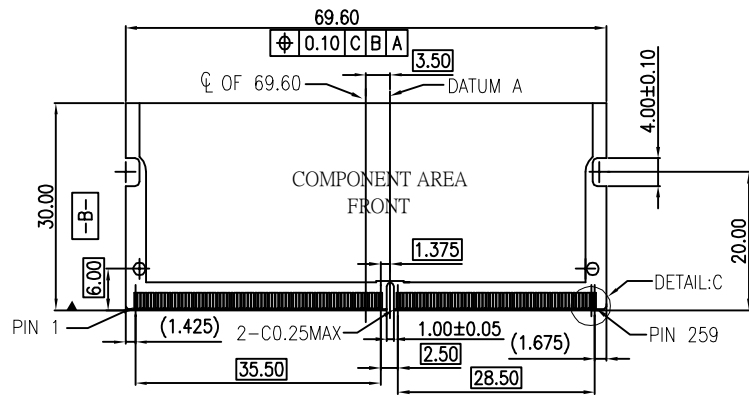

RoHS Compliant

TOLERANCES ARE
X, ±
.X ± 0.30
CHECKED BY GENIUS
.XX ± 0.20
UNIT / mm SCALE 1 : 1
.XXX ±
DATE
ANG ± 3°

照片框

ORDER INFORMATION

SDM5-W92V12R-144116-LF
SERIES | 12V | REEL | LEADFREE
HIGH 9.2mm | 144+116 WAY
90°SMT

DESCRIPTION: DDR4 SDRAM DIMM 260P 9.2H STD C-DWG

MORETHANALL
PCB CONNECTORS
Cable ASSEMBLIES
煜倫股份有限公司
www.morethanall.com

DRAWING BY CY		TOLERANCES ARE
CHECKED BY GENIUS		
UNIT / mm	SCALE 1 : 1	.XXX ± ANG ± 3°
DATE		
SIZE A4	PJECTION	

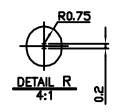
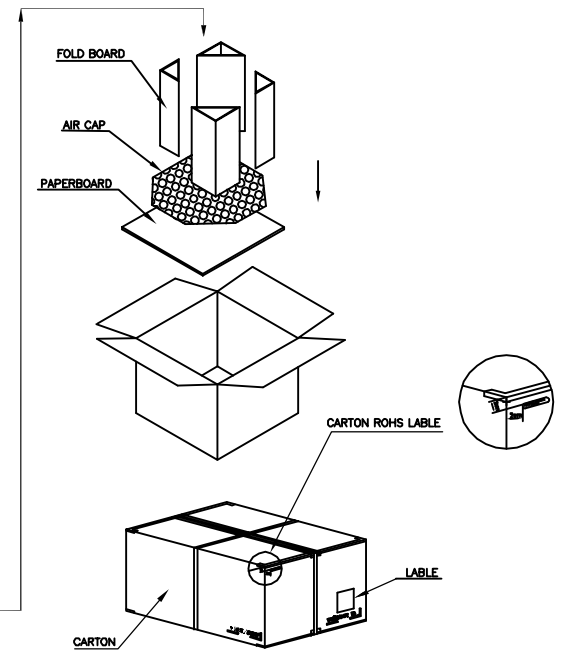
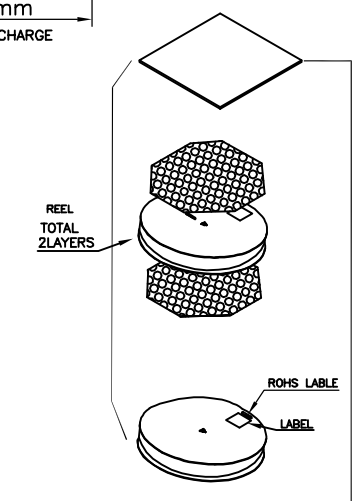
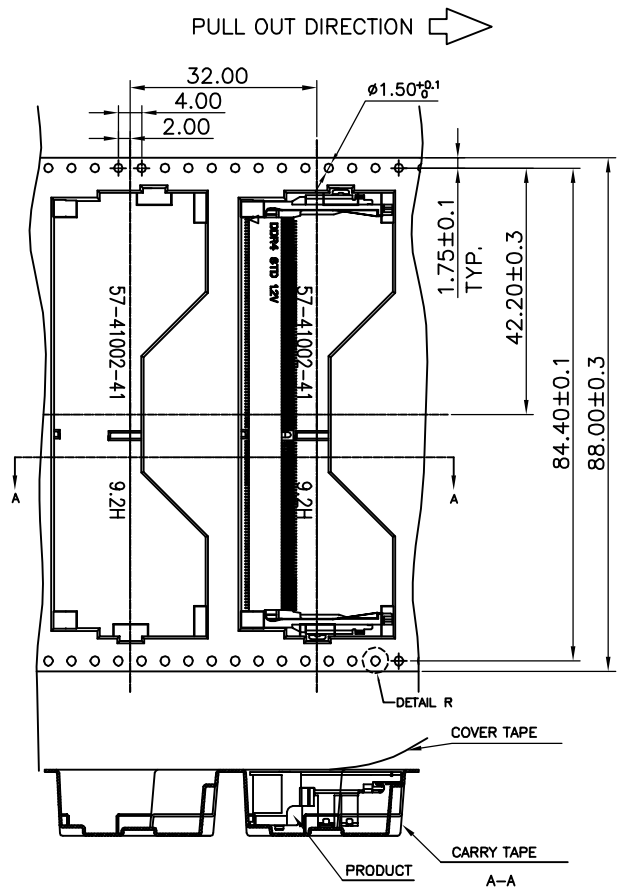
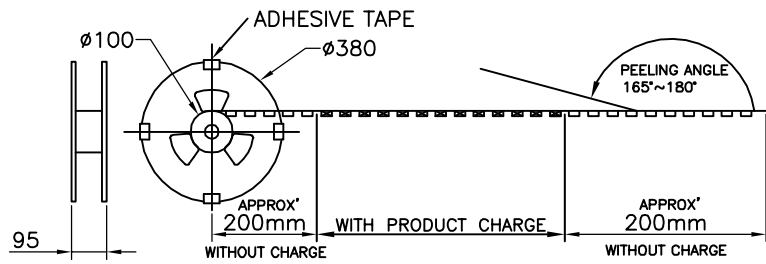

RoHS Compliant

TOLERANCES ARE

MORETHANALL
 PCB CONNECTORS
 Cable ASSEMBLIES
 煜倫股份有限公司
 www.morethanall.com

DRAWING BY CY		X. ± .X ± 0.30 .XX ± 0.20 .XXX ± ANG ± 3°
CHECKED BY GENIUS		
UNIT / mm	SCALE 1 : 1	
DATE		
SIZE A4	PJECTION	

照片框

ORDER INFORMATION

SDM5-W92V12R-144116-LF			
SERIES		REEL	LEADFREE
		12V	144+116 WAY
		HIGH 9.2mm	
		90°SMT	

DESCRIPTION: DDR4 SO DIMM 260P 9.2H STD C-DWG