

備註：

- 1. 材質
  - 1-1. 膠芯: PPS
  - 1-2. 外套: PC
  - 1-3. 端子: 磷銅
- 2. 電鍍
  - 2-1. 端子: 鍍50u"

RP34L-PA-03-LF  
LEADFREE

RoHS Compliant

**MORETHANALL**  
CONNECTORS  
ASSEMBLIES

煜倫股份有限公司

|                      |  |               |            |  |                                |      |           |    |      |
|----------------------|--|---------------|------------|--|--------------------------------|------|-----------|----|------|
| PART NO. RP34L-PA-03 |  | CHECKED BY CY |            | TOLERANCES ARE<br>.X ± 0.2<br>.XX ±<br>.XXX ±<br>AWG | DESCRIPTION: POWER DO3(M) 組裝—1 | AREA | REVISIONS | HK | DATE |
| DWG NO. RP34L-PA-03  |  | DRAWING BY    |            |  |                                |      |           |    |      |
| UNIT / mm            |  | SCALE 1:1     | PROJECTION |  |                                |      |           |    |      |

1 2 3 4 5 6 7 8 9 0

J

I

H

G

F

E

D

C

B

A

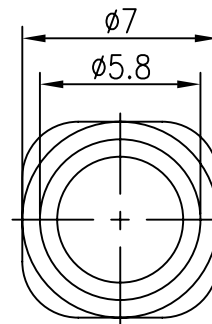
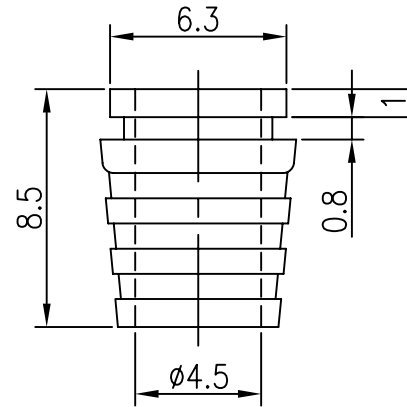
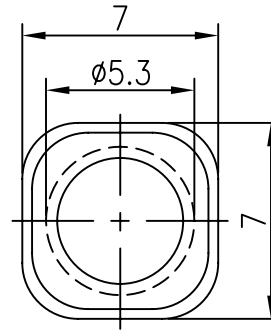

NOTE:  
MATERIAL: PVC



PART NO. RP34L-PA-03

DWG NO. RP34L-PA-03

FILE NO.

CHECKED BY CY

DRAWING BY

TOLERANCES ARE  
.X ± 0.2  
.XX ±  
.XXX ±  
AWG

DESCRIPTION: POWER 3P SRØ4.5

煜倫股份有限公司

UNIT / mm

SCALE 1:1

PROJECTION

AREA

REVISIONS

HK

DATE

1 2 3 4 5 6 7 8 9 0

J  
I  
H  
G  
F  
E  
D  
C  
B  
A

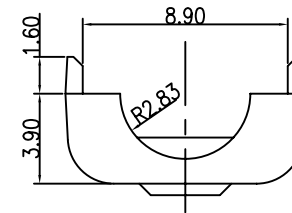
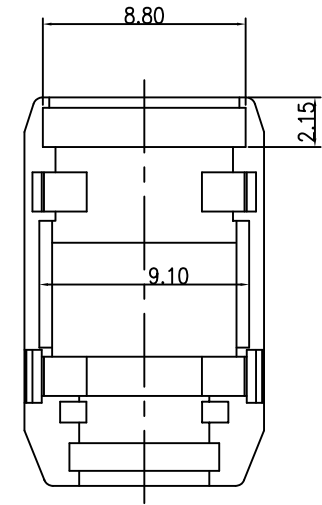
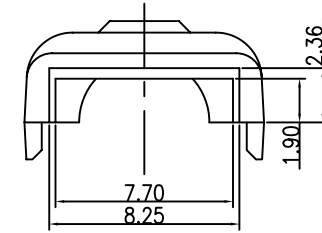
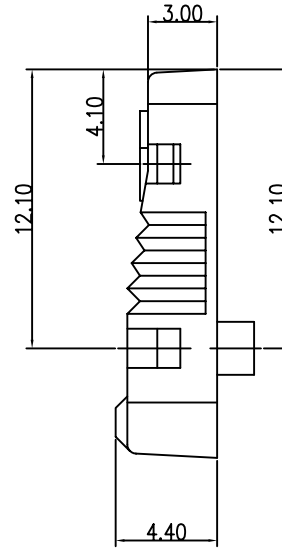
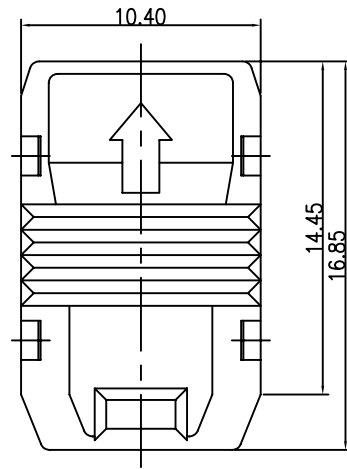

NOTE:  
MATERIAL: PC



PART NO. RP34L-PA-03

DWG NO. RP34L-PA-03

FILE NO.

CHECKED BY CY

DRAWING BY

TOLERANCES ARE

.X ± 0.2  
.XX ±  
.XXX ±  
AWG

DESCRIPTION:

POWER 3P上外蓋

煜倫股份有限公司

UNIT / mm

SCALE 1:1

PROJECTION

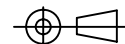

AREA

REVISIONS

HK

DATE

1 2 3 4 5 6 7 8 9 0

J

I

H

G

F

E

D

C

B

A

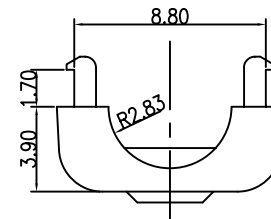
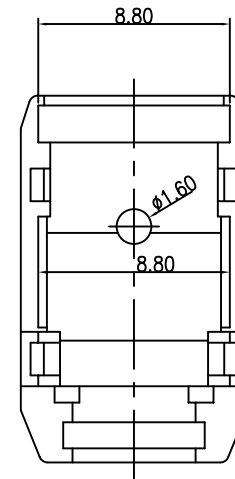
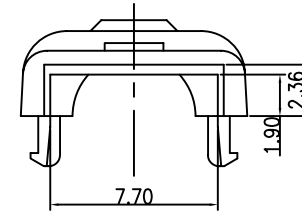
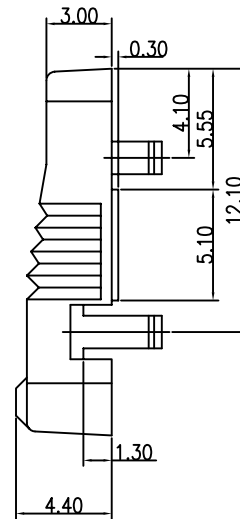
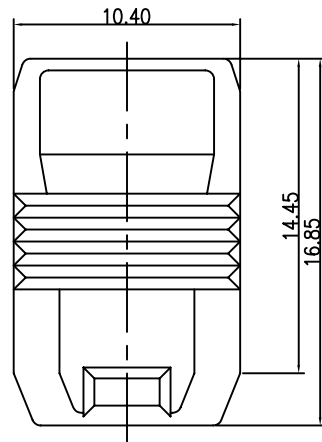

NOTE:  
MATERIAL: PC

**MORETHANALL**  
CONNECTORS  
ASSEMBLIES

PART NO. RP34L-PA-03

DWG NO. RP34L-PA-03

FILE NO.

CHECKED BY CY

DRAWING BY

TOLERANCES ARE

.X ± 0.2

.XX ±

.XXX ±

AWG

DESCRIPTION:

POWER 3P下外壳

AREA

REVISIONS

HK

DATE

煜倫股份有限公司

UNIT / mm

SCALE 1:1

PROJECTION

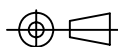

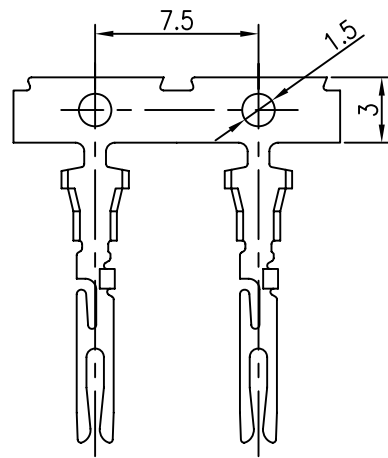

SCALE 3:1

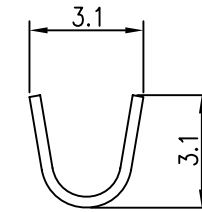
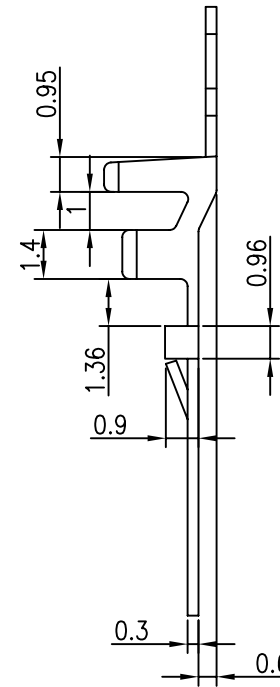
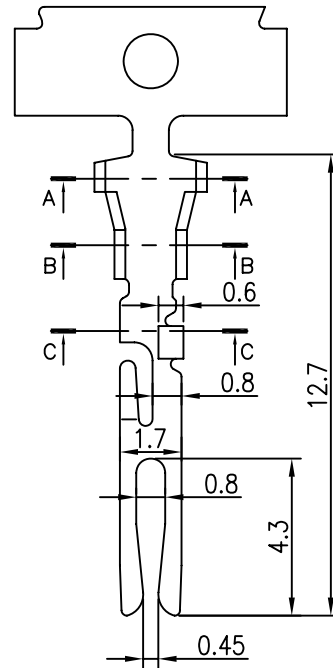

A-A SECTION

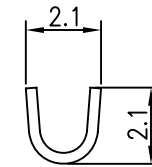

B-B SECTION

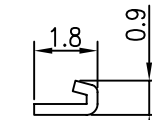

C-C SECTION

備註 / NOTE:

1. 材質 / MATERIAL: 磷銅 / PHOSPHOR BRONZE
2. 電鍍 / PLATING: 鍍 50u" / NICKEL 50u"
3. 毛邊不可過大
4. 不可壓傷變形
5. 不可刮傷露銅

**MORETHANALL**  
CONNECTORS  
ASSEMBLIES

PART NO. RP34L-PA-03

DWG NO. RP34L-PA-03

FILE NO.

UNIT / mm

SCALE 1:1

CHECKED BY CY

DRAWING BY

PROJECTION



TOLERANCES ARE

.X ± 0.2  
.XX ±  
.XXX ±  
AWG

DESCRIPTION:

POWER 3P端子

AREA

REVISIONS

HK

DATE

煜倫股份有限公司

1 2 3 4 5 6 7 8 9 0

J  
I  
H  
G  
F  
E  
D  
C  
B  
A

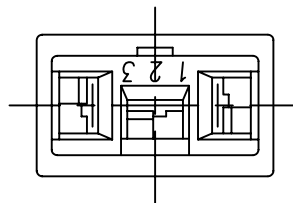
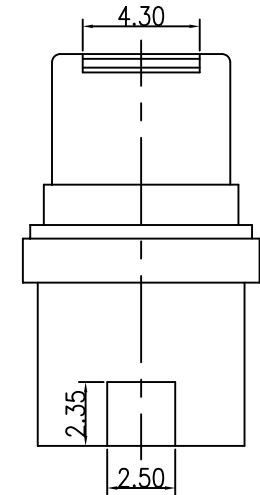
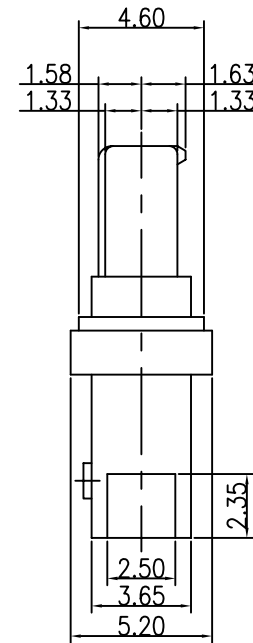
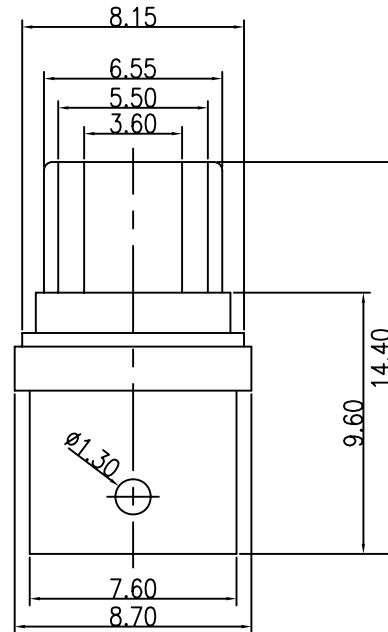
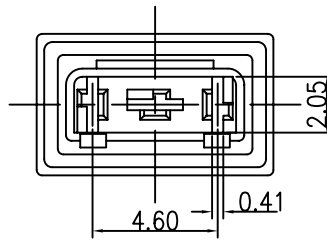

NOTE:  
MATERIAL: PPS

**MORETHANALL**  
CONNECTORS  
ASSEMBLIES

PART NO. RP34L-PA-03

DWG NO. RP34L-PA-03

FILE NO.

CHECKED BY CY

DRAWING BY

TOLERANCES ARE

.X ± 0.2

.XX ±

.XXX ±

AWG

DESCRIPTION:

POWER 3P 膠芯

AREA

REVISIONS

HK

DATE

煜倫股份有限公司

UNIT / mm

SCALE 1:1

PROJECTION

