

Notes:

1. Insulator: Thermalplastic PA66+30%GF, UL94V-0, Nature
2. Terminal: Brass  
Finish: Tin plated 120u" min. overall

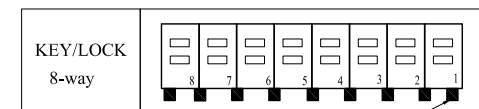

A=C+6.7  
 B=C+5.2  
 C=2.50\*(No. of circuit-1)  
 (8Pin)  
 A=24.2  
 B=22.7  
 C= 17.5

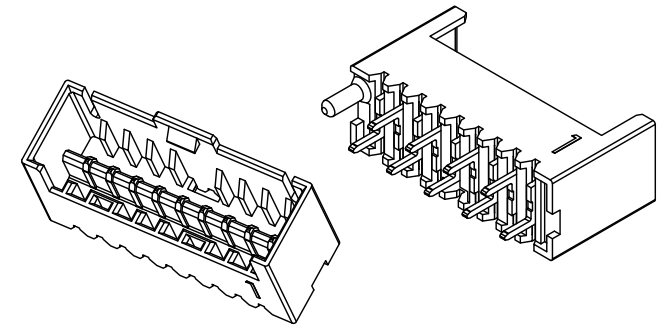
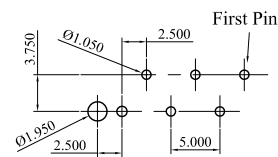
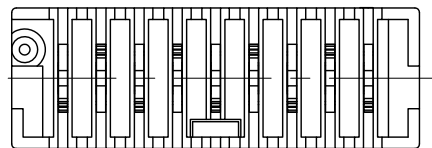

Reverse PCB layout

RoHS Compliant

TOLERANCES ARE

**MORETHANALL**  
 PCB CONNECTORS  
 Cable ASSEMBLIES

DRAWING BY CY

X. ±

CHECKED BY GENIUS

.X ±

UNIT / mm

SCALE 1 : 1

.XX ±

DATE

.XXX ±

ANG ±

SIZE A4

PJECTION

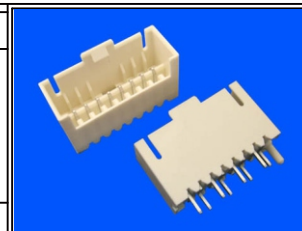

ORDER INFORMATION

RET25-PDPL-xx0yy-LF

SERIES

MALE

POST

DIP 180°

LEADFREE

KEYLOCKTYPE

L POST

02~20 WAY

煜倫股份有限公司

www.morethanall.com

DESCRIPTION:

TYPE	0A	0B
KEY/LOCK		
	2-way	

TYPE	0A	0B	0C	0D	0E	0F	36	37	LA	LB
KEY/LOCK										
	3-way									

TYPE	0A	0B	0C	0D	0E	LA	LB	LC
KEY/LOCK								
	4-way							

TYPE	0A	0B	0C	33	41	LA	LB	LC	LD
KEY/LOCK									
	5-way								

TYPE	0A	0B	LA	LB	LC	LD	LE
KEY/LOCK							
	6-way						

TYPE	0A	0G	60	71	72	LA	LB
KEY/LOCK							
	7-way						

LC	LD	LE	LF

RoHS Compliant

TOLERANCES ARE

**MORETHANALL**  
PCB CONNECTORS  
Cable ASSEMBLIES

DRAWING BY CY

CHECKED BY GENIUS

UNIT / mm

SCALE 1 : 1

DATE

SIZE A4

P PROJECTION

X, ±  
.X ±  
.XX ±  
.XXX ±  
ANG ±

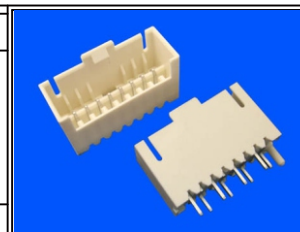

ORDER INFORMATION

RET25-PDPL-xx0yy-LF

SERIES

MALE

POST

LEADFREE

KEYLOCKTYPE

L POST

DIP 180°

02~20 WAY

煜倫股份有限公司

www.morethanall.com

DESCRIPTION:

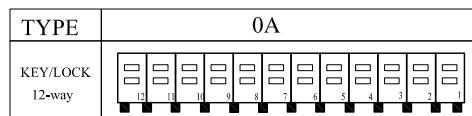
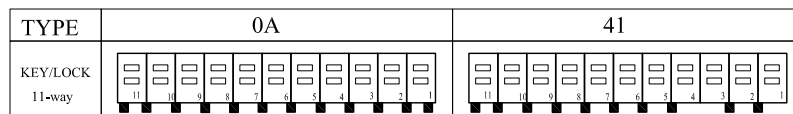
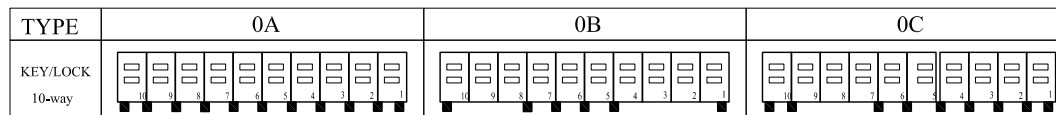
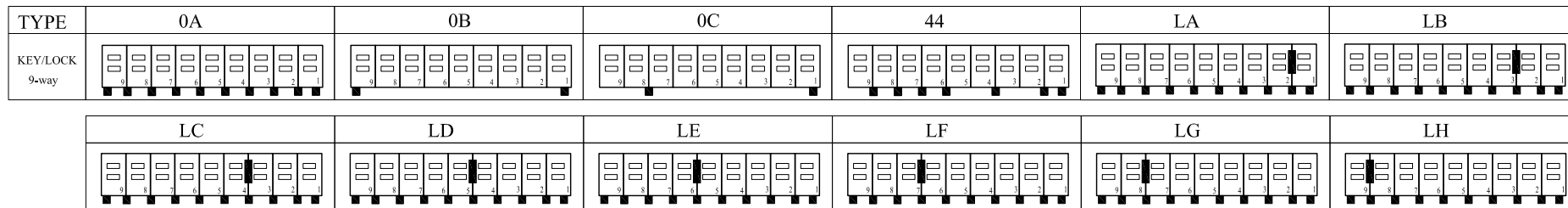
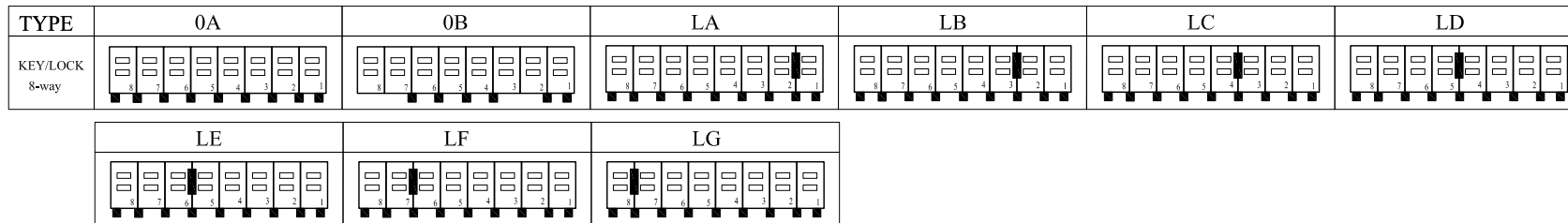

RoHS Compliant

TOLERANCES ARE

**MORETHANALL**  
PCB CONNECTORS  
Cable ASSEMBLIES

DRAWING BY CY

X, ±

CHECKED BY GENIUS

.X ±

UNIT / mm

SCALE 1 : 1

.XXX ±

DATE

ANG ±

SIZE A4

PJECTION

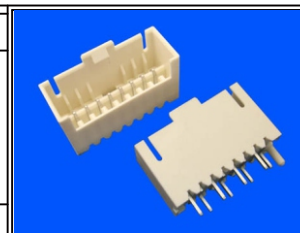

ORDER INFORMATION

RET25-PDPL-xx0yy-LF

SERIES

MALE

POST

DIP 180°

LEADFREE

KEYLOCKTYPE

L POST

02~20 WAY

煜倫股份有限公司

www.morethanall.com

DESCRIPTION:

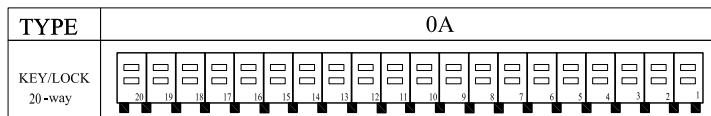
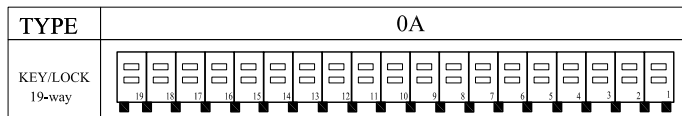
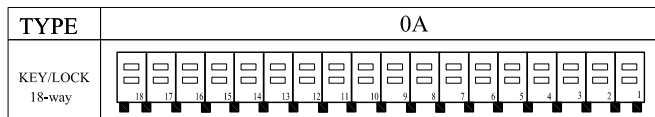
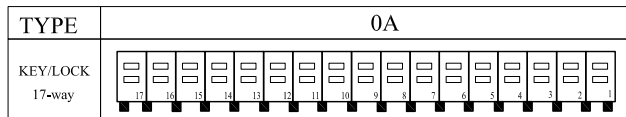
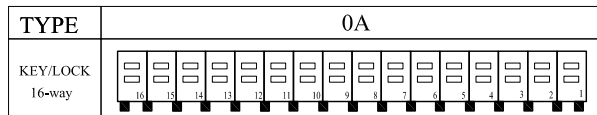
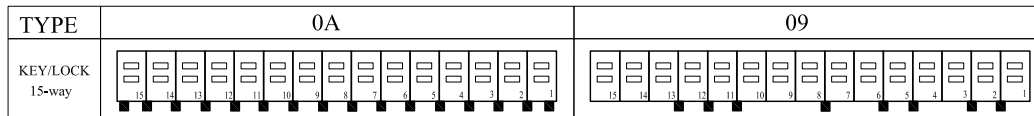
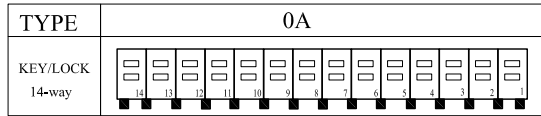
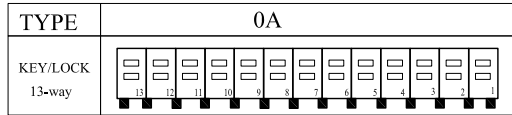

For example:

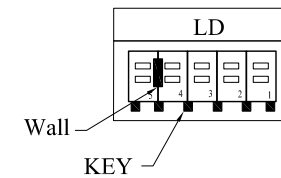

RoHS Compliant

TOLERANCES ARE

**MORETHANALL**  
PCB CONNECTORS  
Cable ASSEMBLIES

DRAWING BY CY

X, ±

CHECKED BY GENIUS

.X ±

UNIT / mm

SCALE 1 : 1

.XXX ±

DATE

ANG ±

SIZE A4

P PROJECTION

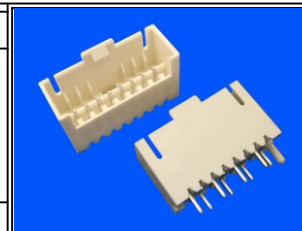

ORDER INFORMATION

RET25-PDPL-xx0yy-LF

SERIES

MALE

POST

DIP 180°

LEADFREE

KEYLOCKTYPE

02~20 WAY

L POST

DESCRIPTION:

煜倫股份有限公司

www.morethanall.com