

一、Mechanical Dimensions

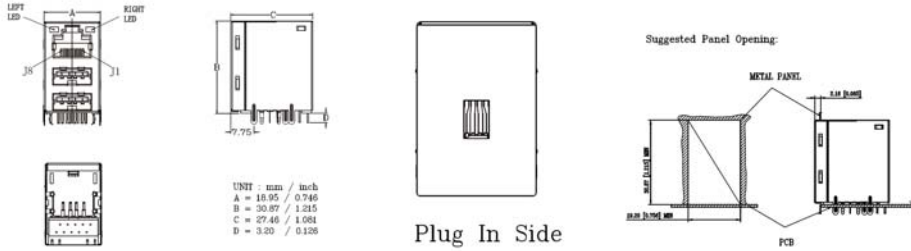

Keep-Out Area (Component Side View):

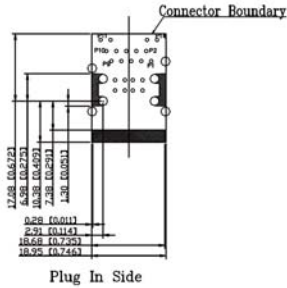

Recommended PWB Layout (Component Side View):

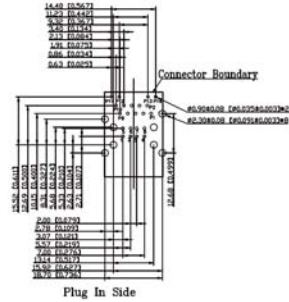

UNIT:mm Unless otherwise specified, all tolerances are ±0.25

二、Schematics

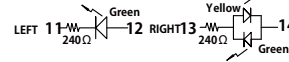
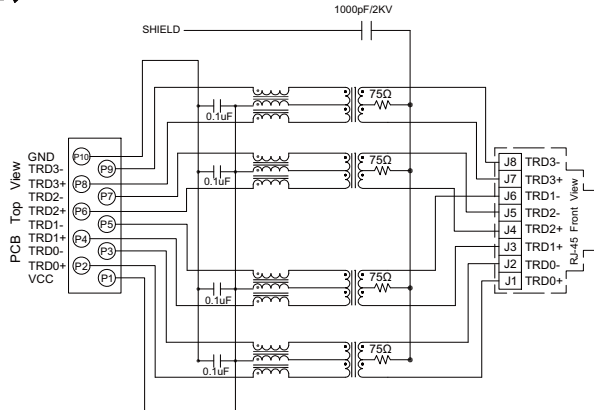

Standard LED	Wavelength	Forward V(MAX)	TYP
Green	565nm	7.0v	5.0v
Yellow	585nm	7.0v	5.0v

With a forward current of 20mA

三、ELECTRICAL SPECIFICATIONS@25 °C:

1. Turn Ratio(±5%): 1CT:1CT
2. Inductance (100KHz/0.1V@ 8mA)350uH MIN
3. Insertion Loss (dB MAX): -1.0dB(1-65MHz)
4. Return Loss (dB TYP): -20dB(1-10MHz),-16dB(30MHz),-12dB(60-80MHz)
5. Cross Talk (dB MIN): -40dB(1-10MHz),-35dB(32-60MHz),-30dB(60-100MHz)
6. CMR (dB TYP): -30dB(1-50MHz),-20dB(50-130MHz)
7. HI-POT(Pri to Sec) : 1500Vrms/0.5mA/60Sec or 1650Vrms/0.5mA/2Sec
8. Operating Temperature: 0°C +70°C
9. RoHS compliance: YES

RoHS Compliant

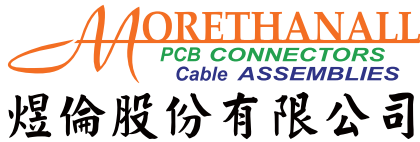

www.morethanall.com

DRAWING BY CY
CHECKED BY GENIUS
UNIT/mm SCALE 1:1
DATE
SIZE A4

TOLERANCES ARE
X, ±
.X ±
.XX ±
.XXX ±
ANG ±

PJECTION

照片框

ORDER INFORMATION

MUJT110UL-KX06XGYG-88AA

SERIES
BLACK
NON EAR
8P8C TO AA TYPE
LEFT / RIGHT
GREEN / YELLOW + GREEN
06u" GOLD

DESCRIPTION: RJ45 1000 BASE-TX JACK / DualUSB Combo

四、Mechanicals:

Notes:

1. CONNECTOR MATERIAL:
 - 1.1 RJ45
HOUSING: PBT BLACK UL94 V-0
SHIELD: Brass
CONTACT: PHOSPHOR BRONZE
CONTACT PLATING: SELECTIVE GOLD, 6 MICRO-INCHS MIN IN CONTACT AREA
 - 1.2 USB2.0
CONTACT: PHOSPHOR BRONZE
CONTACT PLATING: SELECTIVE GOLD, 6 MICRO-INCHS MIN IN CONTACT AREA
2. PIN NOT ELECTRICALLY CONNECTED MAYBE OMITTED SEE ELECTRICAL DRAWING FOR OMITTED PINS
3. RJ45 CAVITIES CONFORM TO FCC RULES AND REGULATION PART 68.
4. OPERATING TEMPERATURE T=0° C TO +70° C.
5. STORAGE TEMPERATURE T=-40° C TO +85° C.

五、Packaging

1. packaging unit : 40 PCS/tray
2. packaging material : PET

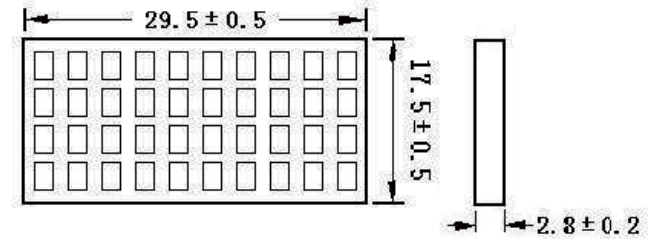

3. outer carton unit 560 pcs/ 14 Trays/box

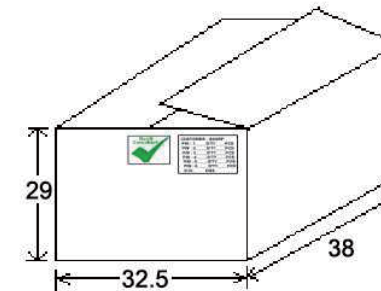

MORETHANALL
PCB CONNECTORS
Cable ASSEMBLIES

煜倫股份有限公司

www.morethanall.com

RoHS Compliant

DRAWING BY CY

CHECKED BY GENIUS

UNIT/mm SCALE 1:1

DATE

SIZE A4

TOLERANCES ARE

X. ±
.X ±
.XX ±
.XXX ±
ANG ±

PJECTION

照片框

ORDER INFORMATION

MUJT110UL-KX06XGYG-88AA

SERIES

BLACK

NON EAR

8P8C TO AA TYPE

LEFT / RIGHT

GREEN / YELLOW + GREEN

06u" GOLD

DESCRIPTION: RJ45 1000 BASE-TX JACK / DualUSB Combo