

| | | | |
|------|---------|------|--|
| 3 | CONTACT | 5 | Pd-Ni 30u"Min.+Au 2u"Min./C5191R-H |
| 2 | HOUSING | 1 | PBT/THERMOPLASTIC, GLASS FILLED,130°C, 94V-ORATE |
| 1 | SHELL | 1 | COPPER ALLOY/C5191R-H |
| ITEM | NAME | Q'TY | MATERIAL / FINISH |

RoHS Compliant

TOLERANCES ARE

MORETHANALL
PCB CONNECTORS
Cable ASSEMBLIES

煜倫股份有限公司

www.morethanall.com

DRAWING BY CY

CHECKED BY GENIUS

UNIT/mm

SCALE 1:1

DATE

SIZE A4

PJECTION

X. ± 0.38
.X ± 0.25
.XX ± 0.13
.XXX ± 0.05
ANG ±

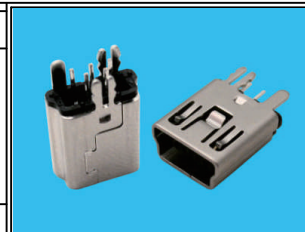

ORDER INFORMATION

MSB-SDM3-5B-LF

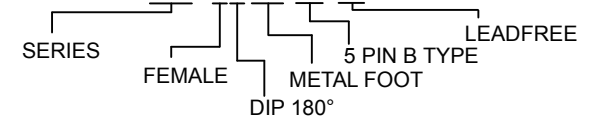

DESCRIPTION:

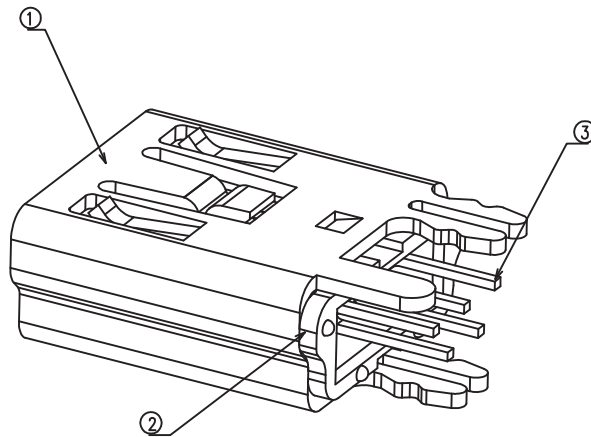

SCALE 8 : 1

- NOTE :
- 1.0. OTHERS :
 - 1.1. PRODUCT SPECIFICATION : CSP-MNC10-00-00
 - 1.2. RECOMMENDED PC BOARD THICKNESS 1.2mm and 1.6mm
 - 1.3. RECOMMENDED PC BOARD MOUNTING DIMENSION : REFER FIGURE A

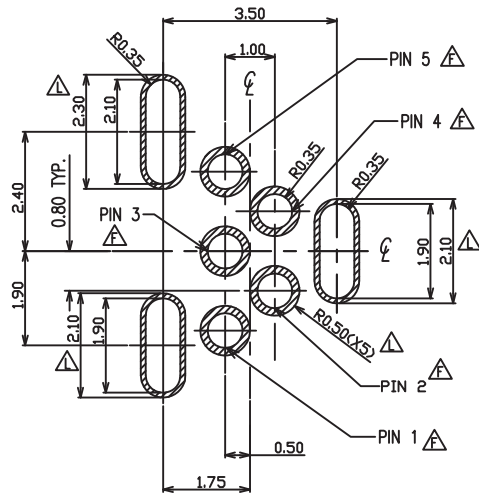

FIGURE A : Printed Circuit Board (PCB) Layout(scale 10 : 1)

RoHS Compliant

TOLERANCES ARE

MORETHANALL
PCB CONNECTORS
Cable ASSEMBLIES

煜倫股份有限公司

www.morethanall.com

DRAWING BY CY

CHECKED BY GENIUS

UNIT/ mm SCALE 1 : 1

DATE

SIZE A4

X. ± 0.38
X. ± 0.25
.XX ± 0.13
.XXX ± 0.05
ANG ±

PJECTION

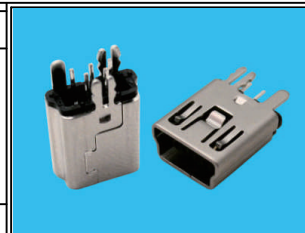

ORDER INFORMATION

MSB-SDM3-5B-LF

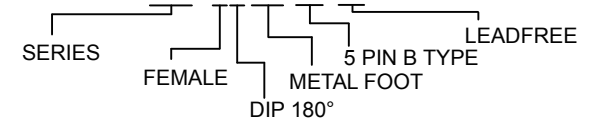

DESCRIPTION:

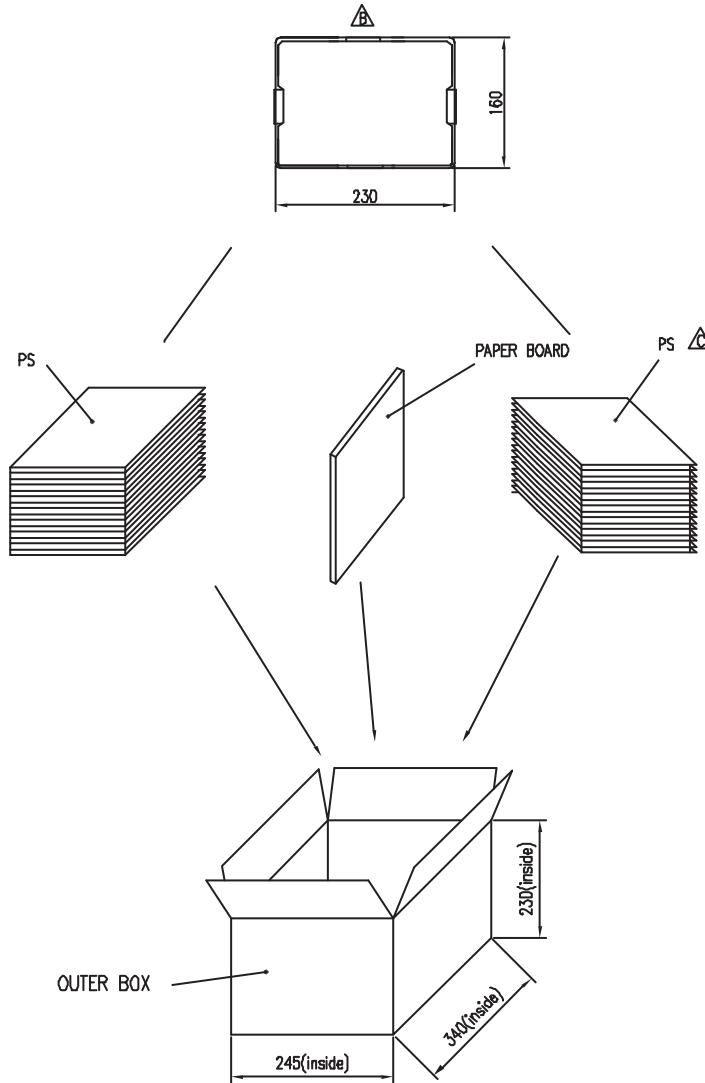

TABLE A:

| PART NAME | PCS/TRAY | PACKAGING QUANTITY | N.W(KGS) | G.W(KGS) |
|-------------|----------|--------------------|----------|----------|
| MSB-SDM3-5B | 150 | (11400) 76TRAY | 9.10 | 12.60 |

RoHS Compliant

TOLERANCES ARE

MORETHANALL
PCB CONNECTORS
Cable ASSEMBLIES

煜倫股份有限公司

www.morethanall.com

DRAWING BY CY

CHECKED BY GENIUS

UNIT/mm SCALE 1:1

DATE

SIZE A4

X. ± 0.38
.X ± 0.25
.XX ± 0.13
.XXX ± 0.05
ANG ±

PJECTION



ORDER INFORMATION

MSB-SDM3-5B-LF

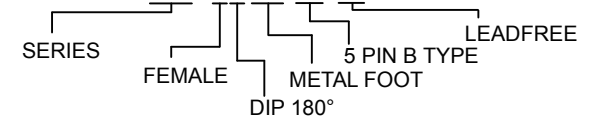

DESCRIPTION: PACKAGE SPECIFICAT

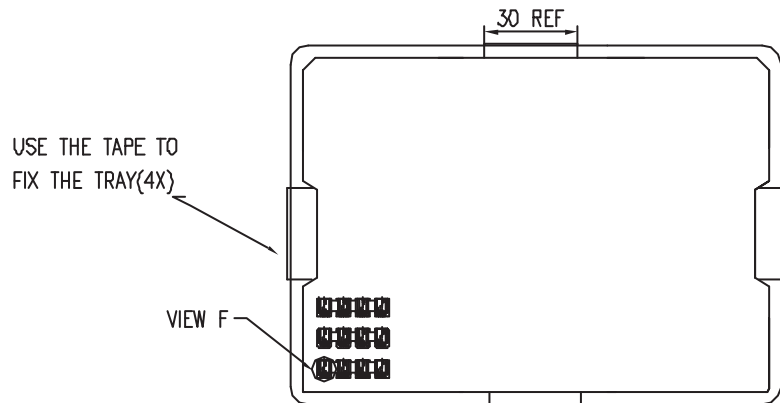

{FIGURE E} HIGHT: 6 mm

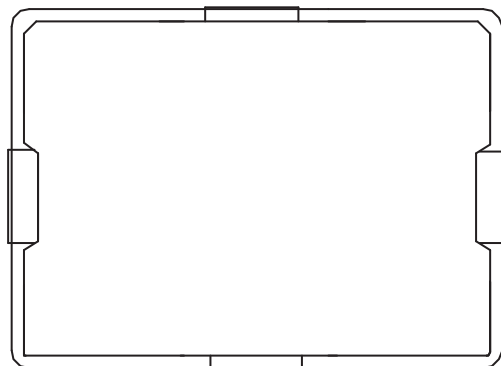

{FIGURE E} HIGHT: 6 mm

⚠ NOTES:

1. PACKAGING QUANTITY AND N.W&G.W : SEE TABLE A
2. USE THE TAPE TO LABEL THE TRAY (SEE THE FIGURE E)
3. THE P/N OF TRAYS : SEE THE TABLE C.
4. THE P/N OF PAPER BOARD & QUTER BOX :SEE THE TABLE C
5. THE PACKING UPPER PVC AND DOWN PVC NEED TO BE USED EPE FOAM.
6. THE BOX'S AND TRAY'S DIMENSIONS WILL BE REFERENCE.

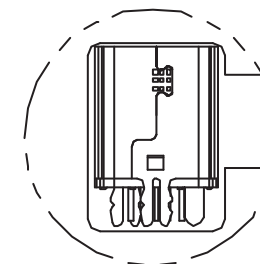

VIEW F

MORETHANALL
PCB CONNECTORS
Cable ASSEMBLIES

煜倫股份有限公司

www.morethanall.com

RoHS Compliant

DRAWING BY CY

CHECKED BY GENIUS

UNIT/mm SCALE 1:1

DATE

SIZE A4

TOLERANCES ARE

X. ± 0.38

.X ± 0.25

.XX ± 0.13

.XXX ± 0.05

ANG ±

PJECTION



ORDER INFORMATION

MSB-SDM3-5B-LF

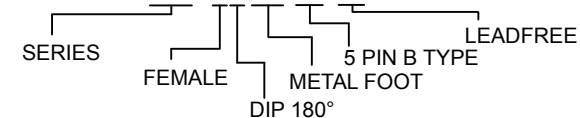

DESCRIPTION: