

1. MECHANICAL DIMENSIONS :

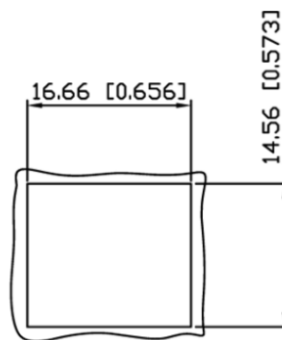

RECOMMENDED
PANEL CUTOUT DIMENSION

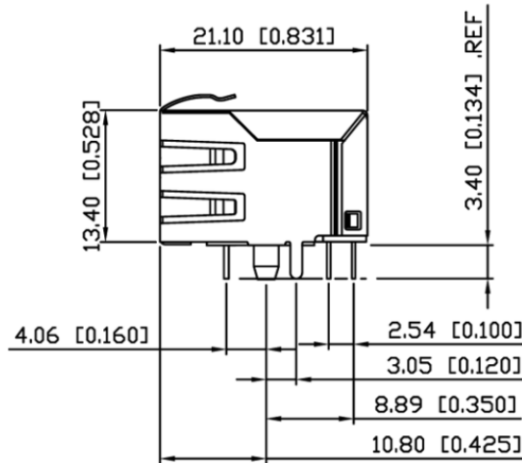
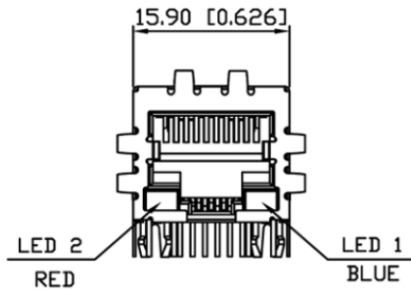

NOTES:

1. MATERIALS:
HOUSING-PBT POLYESTER UL94V-0
MIXED GLASS FIBER.
STANDARD COLOR-BLACK.
CONTACTS-0.35mm THICK PHOS-BRONZE PLATED
WITH GOLD IN CONTACT AREA, TIN IN
SOLDER AREA, AND UNDERPLATED NICKEL
IN ALL AREA.
SHIELD-0.25mm THICK COPPER ALLOY,
PLATED WITH NICKEL.
2. OPERATING TEMPERATURE : 0°C~70°C
3. CAVITY CONFORMS TO FCC RULES AND REGULATIONS
PART 68,SUBPART F.
4. UNSPECIFIED TOLERANCE: .XX ±0.25[0.010]
.X ±0.30[0.012]

RECOMMENED PLUG DIMENSION:

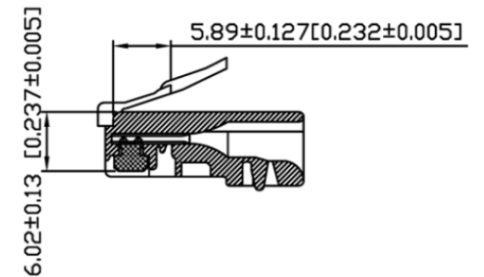

RoHS Compliant

TOLERANCES ARE

MORETHANALL
PCB CONNECTORS
Cable ASSEMBLIES

煜倫股份有限公司

www.morethanall.com

DRAWING BY CY

CHECKED BY GENIUS

UNIT / mm SCALE 1 : 1

DATE

SIZE A4

X, ±
.X ± 0.30
.XX ± 0.25
.XXX ±
ANG ±

PJECTION

照片框

ORDER INFORMATION

MJF13T36L-KF06B3RB-0808-LF

SERIES BLACK FULL SPRING
LED2 / LED1 RED / BLUE
8P8C LEADFREE
REAR TAB 3.05mm
06u" GOLD

DESCRIPTION:

2. PCB LAYOUT :

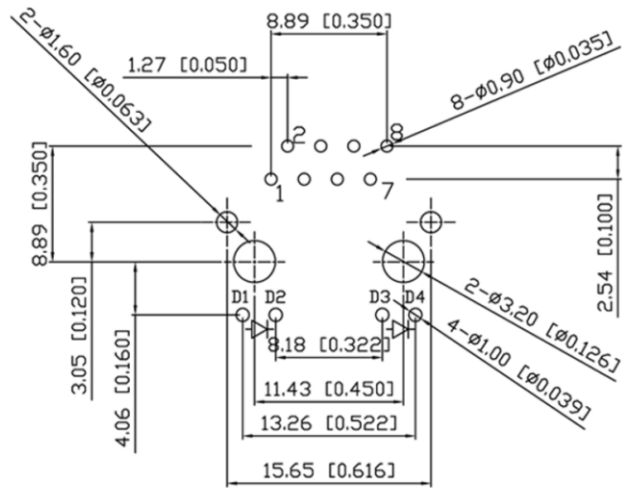

SUGGESTED PCB LAYOUT
(TOP VIEW)

DIMENSIONAL TOLERANCE: .XX ±0.08[0.003]

4. SCHEMATIC:

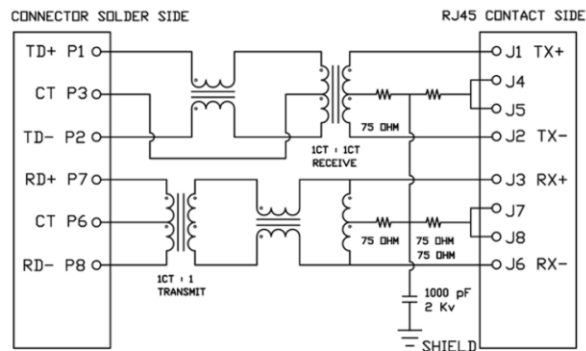

3. LED CONFIGURATION :

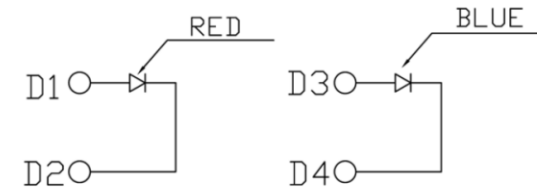

5. ELECTRICAL CHARACTERISTICS :

TEST NOTES:(25±5°C)

1.TR:(100KHz,0.1V);

PINS:(P1-P2):(J1-J2)=1:1±3%

PINS:(P7-P8):(J3-J6)=1:1±3%

2.LX:(100KHz,100mV,8mA, DC Bias)

PINS: (P1,P2),(P7,P8)=350uH MINIMUM

3.DCR:

PINS:(J1-J2),(J3-J6)= 1.2 OHMS MAXIMUM

4.HIPDT:

PINS(P1,P3,P2)TO(J1,J2)=1500VAC FOR 60 SECONDS

PINS(P7,P6,P8)TO(J3,J6)=1500VAC FOR 60 SECONDS

5.INSERTION LOSS:

-1.0dB MAXIMUM AT 0.3MHz TO 100MHz;

6.RETURN LOSS:

-20dB MINIMUM AT 1MHz TO 30MHz;

-15dB MINIMUM AT 30MHz TO 60MHz

-10dB MINIMUM AT 60MHz TO 80MHz

7.CROSS TALK:

-30dB MINIMUM AT 1MHz TO 100MHz

8.COMMON TO COMMON MODE REJECTION:

-30dB MINIMUM AT 1MHz TO 100MHz

RoHS Compliant

TOLERANCES ARE

MORETHANALL
PCB CONNECTORS
Cable ASSEMBLIES

DRAWING BY CY

X, ±

CHECKED BY GENIUS

.X ± 0.30

UNIT / mm

SCALE 1 : 1

.XX ± 0.25

DATE

.XXX ±

ANG ±

SIZE A4

PJECTION

照片框

ORDER INFORMATION

MJF13T36L-KF06B3RB-0808-LF

SERIES

BLACK

FULL SPRING

8P8C

LEADFREE

LED2 / LED1

RED / BLUE

REAR TAB 3.05mm

06u" GOLD

煜倫股份有限公司

www.morethanall.com

DESCRIPTION: