

TOP VIEW

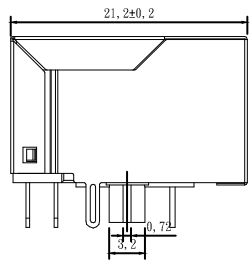

LEFT SIDE VIEW

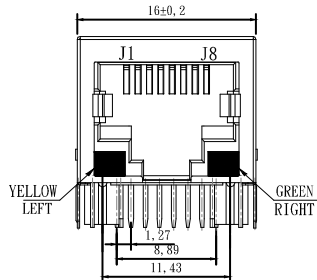

FRONT VIEW

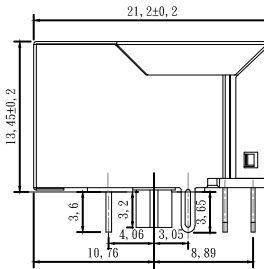

RIGHT SIDE VIEW

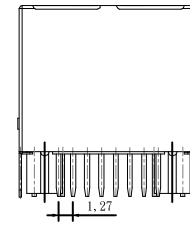

BACK VIEW

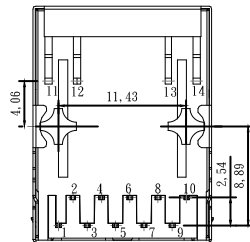
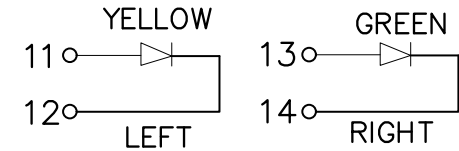

BOTTOM VIEW

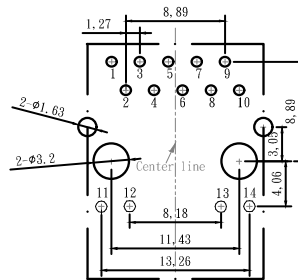

RECOMMENDED PCB LAYOUT
VIEWED FROM COMPONENT SIDE

MATERIAL:

HOUSING : PBT, UL94V-0, BLACK.
 TERMINALS BRACKET: PBT, UL94V-0, BLACK.
 SHIELD: C2680, T=0.20MM, NICKEL PLATING ON ALL AREA.
 TERMINAL: PHOSPHOR BRONZE C5210, T=0.35MM,
 6U" GOLD PLATING ON CONTACT AREA.

MECHANICAL:

DURABILITY : 750 CYCLES MIN.
 MATING FORCE : 23N MAX.
 OPERATING TEMPERATURE: -40° C~+85° C.
 STORAGE TEMPERATURE: -40° C~+85° C.
 ALL CRITICAL DIMENSIONS WITH "*"

LED Specification

| Standard LED Color | LED Wavelength | Foward(A) | Foward(V) |
|--------------------|----------------|-----------|------------|
| Green | 568nm | 20mA | 1.85-2.45V |
| Yellow | 585nm | 20mA | 1.7-2.2V |

RoHS Compliant

TOLERANCES ARE

MORETHANALL
 PCB CONNECTORS
 Cable ASSEMBLIES

DRAWING BY CY

CHECKED BY GENIUS

UNIT / mm

SCALE 1 : 1

DATE

SIZE A4

PJECTION

X. ±
 .X ± 0.25
 .XX ± 0.15
 .XXX ± 0.05
 ANG ±

照片框

ORDER INFORMATION

MJF13T009L-KX06B3YG-0808

SERIES

8P8C
 YELLOW / GREEN
 REAR TAB 3.05mm
 06u" GOLD
 NON EAR
 BLACK

DESCRIPTION: TAB DOWN 1X1 1000BASE

煜倫股份有限公司

www.morethanall.com

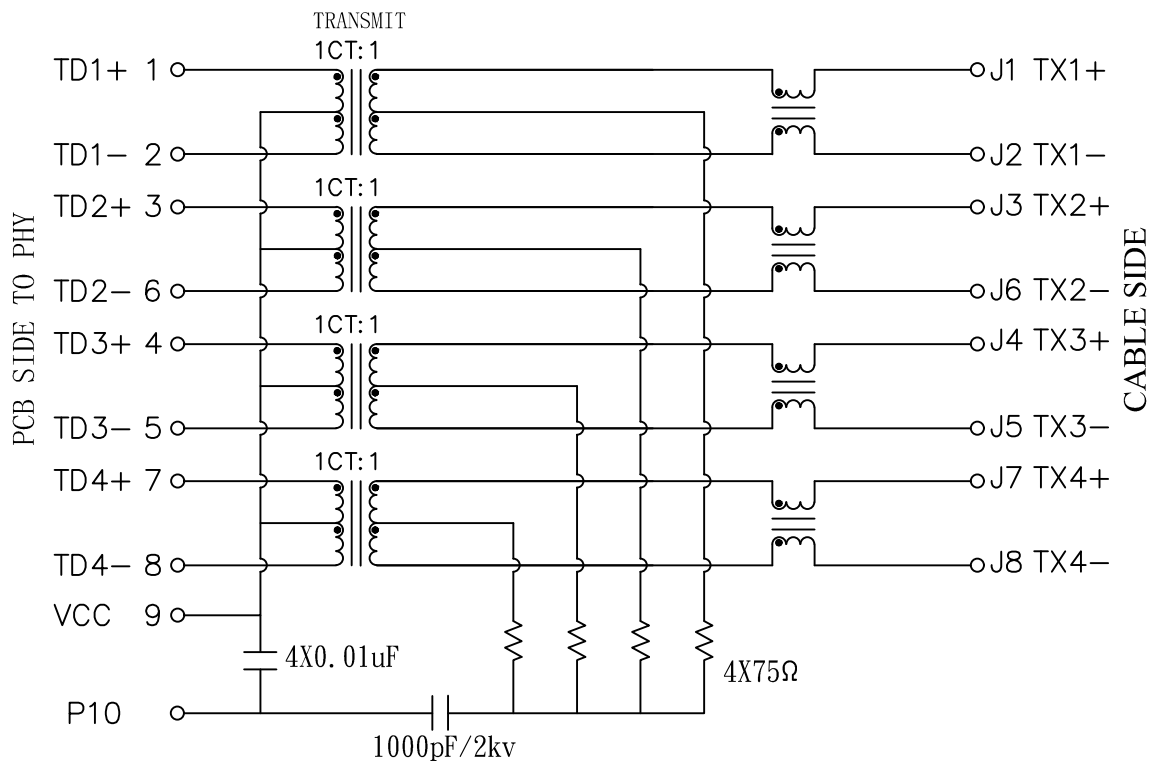

Electrical:

1. Turn ratio: 1~2: J1~J2=1CT:1CT (±2%).
3~6: J3~J6=1CT:1CT (±2%).
4~5: J4~J5=1CT:1CT (±2%).
7~8: J7~J8=1CT:1CT (±2%).
2. OCL: 350uH Min. at 100KHz 100mV 8mA DC.
3. Insertion Loss: -1.0 dB Max 1~100MHz.
4. Return loss: -18dB Min 1~30MHz;
-14dB Min 30~60MHz.
-12dB Min 60~80MHz.
-10dB Min 80~100MHz.
5. Cross talk: -40dB Min 1~30MHz;
-35dB Min 30~60MHz;
-30dB Min 60~100MHz;
6. CMR: -30dB Min 1~100MHz;
7. Hi-Pot: 1500V AC & 2250V DC
6S 1mA PRI TO SEC

RoHS Compliant

TOLERANCES ARE

MORETHANALL
PCB CONNECTORS
Cable ASSEMBLIES

DRAWING BY CY

CHECKED BY GENIUS

UNIT / mm SCALE 1 : 1

DATE

SIZE A4 PPROJECTION

X, ±
.X ± 0.25
.XX ± 0.15
.XXX ± 0.05
ANG ±

照片框

ORDER INFORMATION

MJF13T009L-KX06B3YG-0808

SERIES

8P8C
YELLOW / GREEN
REAR TAB 3.05mm
06u" GOLD
NON EAR
BLACK

DESCRIPTION: TAB DOWN 1X1 1000BASE

煜倫股份有限公司

www.morethanall.com