

一、Mechanical Dimensions

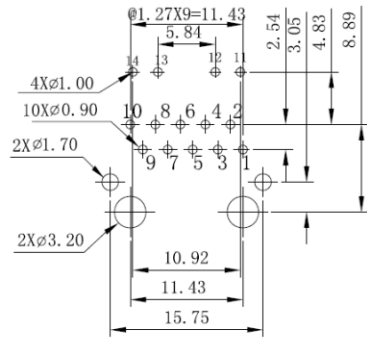

PC Board Layout
Component Side Shown

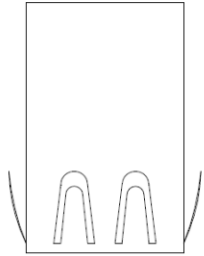
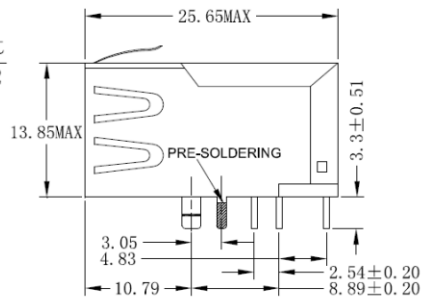
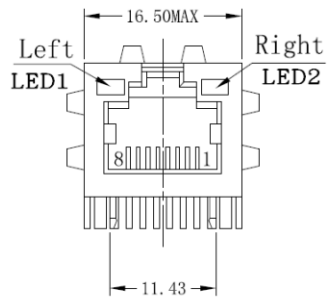

UNIT:mm Unless otherwise specified, all tolerances are ± 0.25

二、Schematics

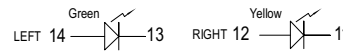
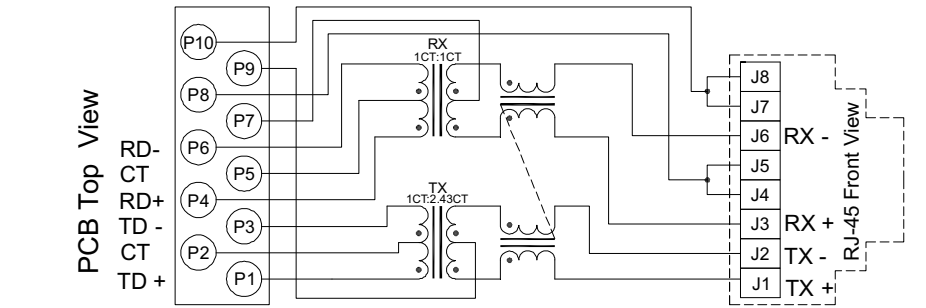

Standard LED	Wavelength	Forward*V(MAX)	TYP
Green	565nm	2.5v	2.2v
Yellow	585nm	2.5v	2.1v

With a forward current of 20mA

三、ELECTRICAL SPECIFICATIONS@25°C:

1. Turn Ratio(?%): TX=1CT:2.43CT,RX=1CT:1CT
2. Inductance(100KHz/0.1V): TX: 45uH MIN, RX:230uH MIN
3. RX Insertion Loss(dB MAX): -1.0dB(1-10MHz).
4. RX Return Loss(dB MIN): -18dB(1-10MHz).
5. RX CMR (dB MIN): -40dB(10-30MHz),-30dB(100MHz)
6. HI-POT(Pri to Sec): 1000Vrms/0.5mA/2Sec
7. Operating Temperature:0°C TO +70°C
8. RoHS compliance: YES

RoHS Compliant

TOLERANCES ARE

MORETHANALL
PCB CONNECTORS
Cable ASSEMBLIES

煜倫股份有限公司

www.morethanall.com

DRAWING BY CY

CHECKED BY GENIUS

UNIT / mm SCALE 1 : 1

DATE

SIZE A4

P PROJECTION

X, ±
.X ±
.XX ±
.XXX ±
ANG ±

照片框

ORDER INFORMATION

MJF13P25UL-KF06B3GY-0808

SERIES 8P8C

BLACK LED1 / LED2

FULL SPRING GREEN / YELLOW

REAR TAB 3.05mm

06u" GOLD

DESCRIPTION: 10 Base-T POE Single Port Rj-45 Jack Magnetics

四、Mechanicals

Housing Material:

MATERIAL:NYLON GF (Fr50) UL94V-0 STANDARD COLOR:BLACK

Insert Material:

MATERIAL:Phos ronze C5210 EH---0.35mm Thickness

Insert PBT GF UL94V-0

1.PLATING(1) NICKEL

2.PLATING(2) 100%Sn

3.PLATING(3) GOLD (3u " ~50u ")

Plate Material:

PBT GF UL 94V-0

Contact pin Material:

MATERIAL: Phos ronze C5191---0.35mm Thickness

1.PLATING(1) NICKEL

2.PLATING(2) 100%Sn

Shielding Material:

BRASS C2680 PLATING NICKEL

Operating Life:750 Cycles MIN.

五、Environmental

1.Storage Temp:-40TO +85°C.

2.Operating Temp:0TO +70°C.

3.MATES WITH MODULAR PLUG CONFORMING TO FCC PART 68,SUBPART F.

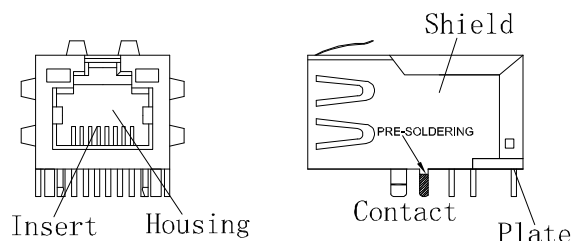

六、Packaging

1. packaging unit : 60 PCS/tray

2. packaging material : PET

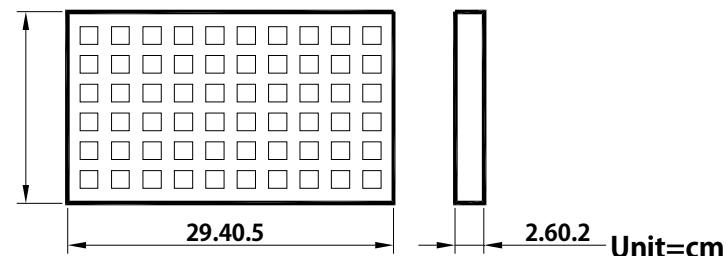

3. outer carton unit:1080 pcs/ 18 Trays/box

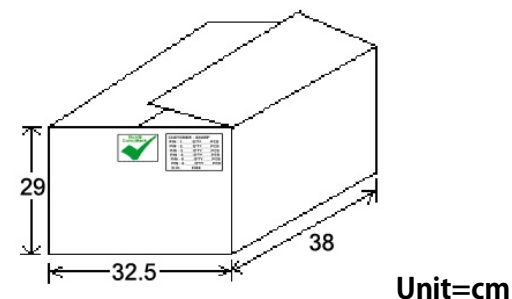

MORETHANALL
PCB CONNECTORS
Cable ASSEMBLIES
煜倫股份有限公司

www.morethanall.com

RoHS Compliant

TOLERANCES ARE

DRAWING BY CY

CHECKED BY GENIUS

UNIT / mm SCALE 1 : 1

DATE

SIZE A4

X, ±
.X ±
.XX ±
.XXX ±
ANG ±

PJECTION

照片框

ORDER INFORMATION

MJF13P25UL-KF06B3GY-0808

SERIES 8P8C
BLACK LED1 / LED2
FULL SPRING GREEN / YELLOW
REAR TAB 3.05mm
06u" GOLD

DESCRIPTION: 10 Base-T POE Single Port Rj-45 Jack Magnetics