

RECOMMENDED PCB LAYOUT

Note:

1. Material:
 - 1.1 Housing: High temperature thermoplastic with g.f, UL94v-0
 - 1.2 Contact: copper alloy, t=0.20mm
 - 1.3 Shell: SUS, t=0.25mm
2. Specification:
 - 2.1 Current rating: 1 A Max.
 - 2.2 Dielectric withstanding voltage: 100 V(ac) for 1 min.
 - 2.3 Contact resistance: 50 mW Max.
 - 2.4 Insulation resistance: 100 MW Min.
 - 2.5 Total mating force: 3.57 Kgf Max.
 - 2.6 Total unmating force: 1.0 Kgf Min. 0.81~2.05 Kgf Min. after 3000 insertion/extraction cycles
 - 2.7 Temperature range: -30° C~80° C

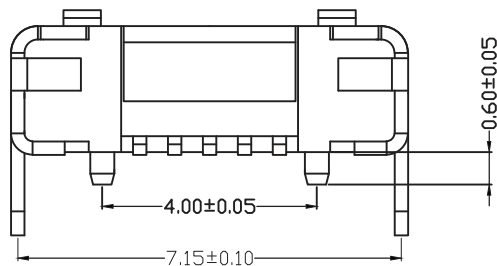
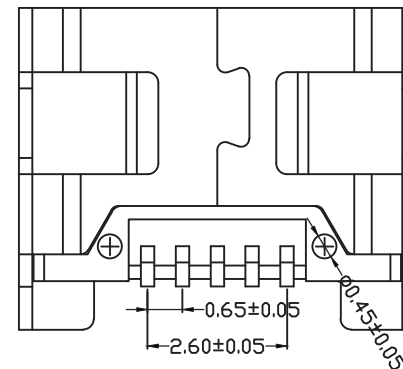
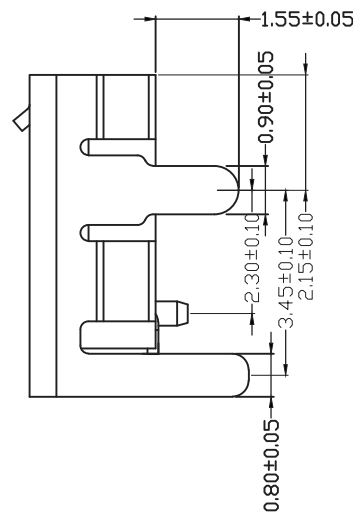
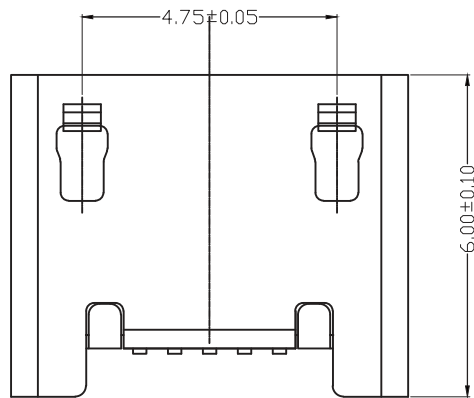

RoHS Compliant

TOLERANCES ARE

MORETHANALL
PCB CONNECTORS
Cable ASSEMBLIES

DRAWING BY CY

X. ± 0.50

CHECKED BY GENIUS

.X ± 0.20

UNIT / mm

SCALE 1 : 1

.XX ± 0.10

DATE

.XXX ± 0.03

ANG ± 1°

照片框

ORDER INFORMATION

MISB-SWFXMM7171P40R-5B-LF
 SERIES | | | | | LEADFREE
 FEMALE | | | | | 5 PIN B TYPE
 90°SMT | | | | | REEL
 NON FLANGE | | | | | POST 4.0mm
 METAL FOOT 7.15+7.15mm

煜倫股份有限公司

www.morethanall.com

SIZE A4

PJECTION

DESCRIPTION:

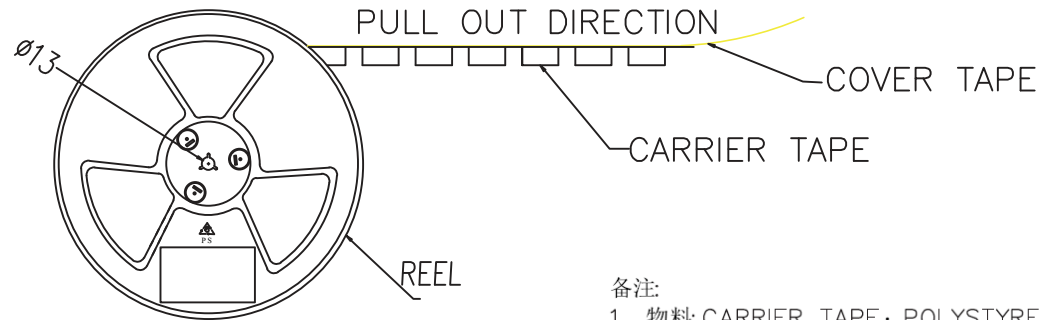
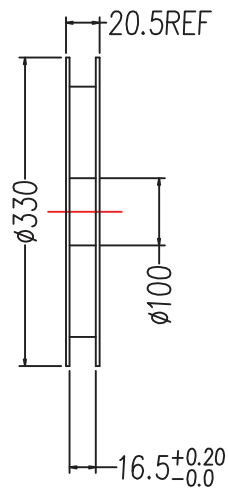
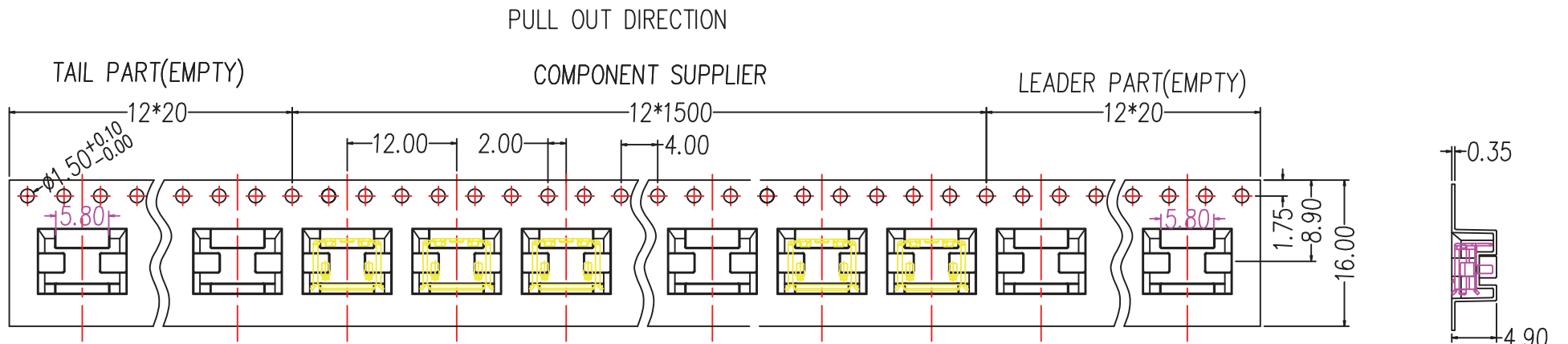

备注:

- 1、物料: CARRIER TAPE: POLYSTYREN (PS) ; COVER TAPE: POLYSTYREN (PS) ; REEL: POLYSTYREN (PS)
- 2、包装数量: 1000PCS/REEL, 15REEL/CARTON, 共 15000PCS/CARTON
- 3、剥离力: 0.3N~1N (跳动量在0.3N内) ; 剥离角度: 165°~175°; 剥离速度: 250~300mm/min
- 4、包装方式: CARRY TAPE 前部分与尾部分各留出240mm长度 (即20个空格) 不装产品

RoHS Compliant

TOLERANCES ARE

MORETHANALL
PCB CONNECTORS
Cable ASSEMBLIES

煜倫股份有限公司

www.morethanall.com

DRAWING BY CY

CHECKED BY GENIUS

UNIT / mm SCALE 1 : 1

DATE

SIZE A4

X, ±
.X ± 0.25
.XX ± 0.15
.XXX ± 0.05
ANG ± 1°

P PROJECTION

照片框

ORDER INFORMATION

MISB-SWFXMM7171P40R-5B-LF
SERIES | | | | | LEADFREE
FEMALE | | | | | 5 PIN B TYPE
90°SMT | | | | | REEL
NON FLANGE | | | | | POST 4.0mm
METAL FOOT 7.15+7.15mm

DESCRIPTION:

TOTAL
7LAYERS

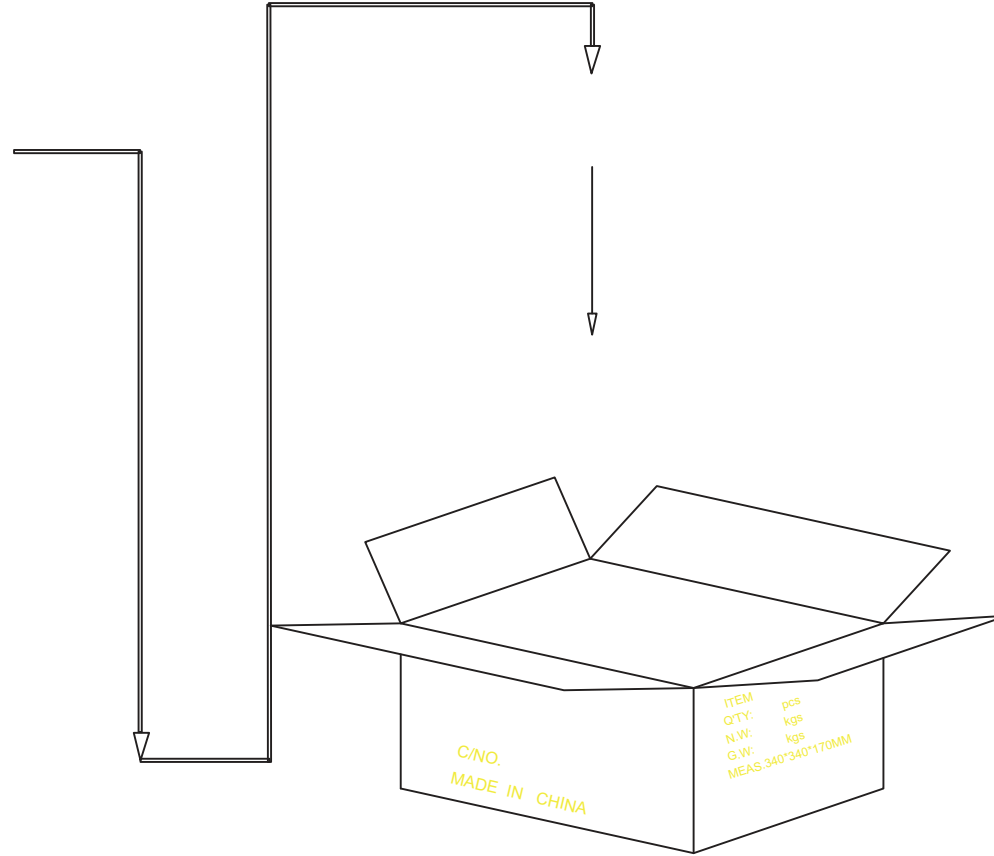
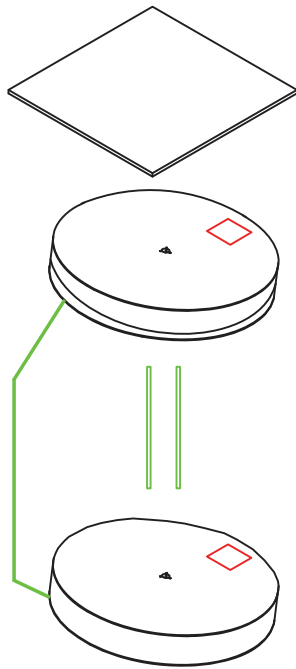

紙箱規格 340*340*170 7 盤/箱

RoHS Compliant

TOLERANCES ARE

MORETHANALL
PCB CONNECTORS
Cable ASSEMBLIES

煜倫股份有限公司

www.morethanall.com

DRAWING BY CY

CHECKED BY GENIUS

UNIT / mm

SCALE 1:1

DATE

SIZE A4

X. ±
.X ± 0.25
.XX ± 0.15
.XXX ± 0.05
ANG ± 1°

PPOJECTION

照片框

ORDER INFORMATION

MISB-SWFXMM7171P40R-5B-LF
SERIES | | | | | LEADFREE
FEMALE | | | | | 5 PIN B TYPE
90°SMT | | | | | REEL
NON FLANGE | | | | | POST 4.0mm
METAL FOOT 7.15+7.15mm

DESCRIPTION:

TOTAL
15LAYERS

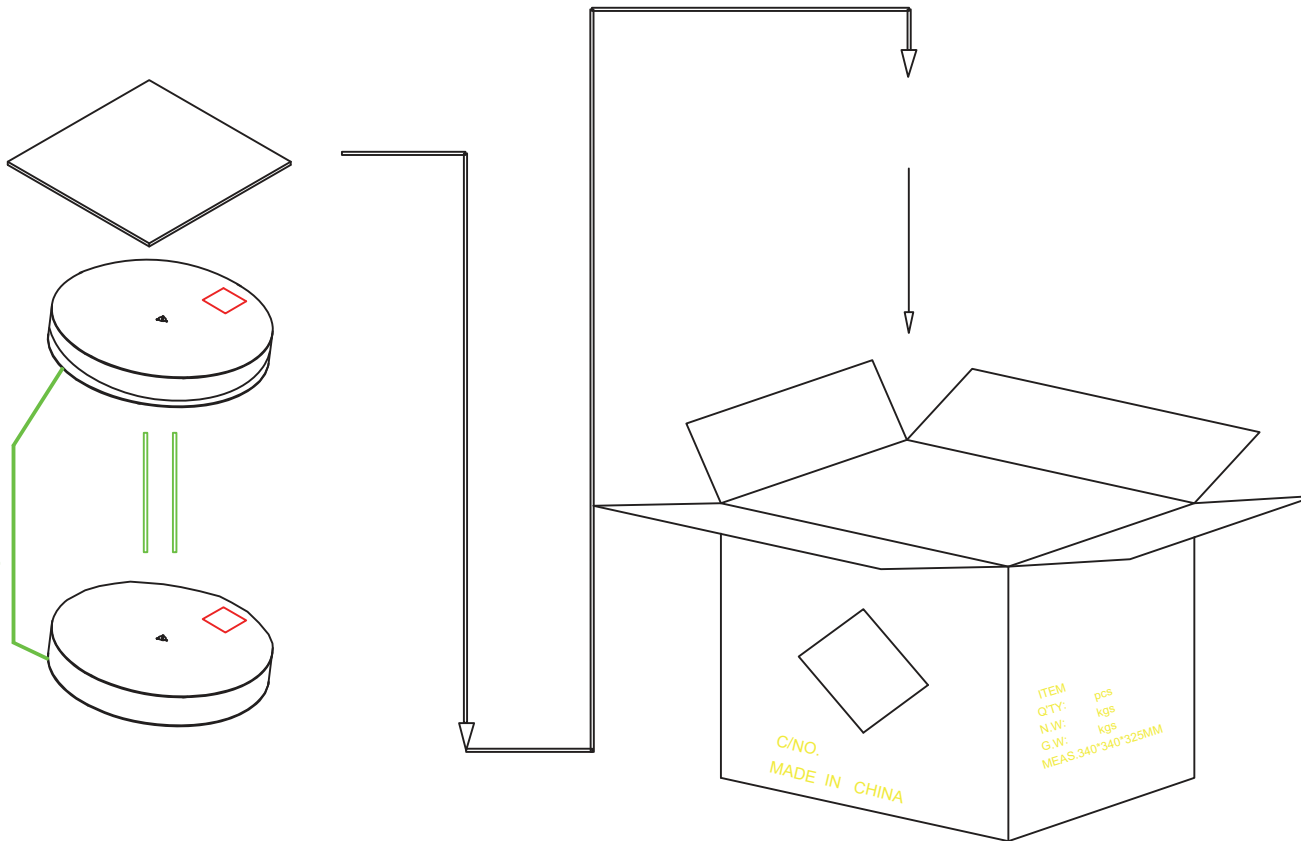

紙箱規格 340*340*325 15 盤/箱

RoHS Compliant

TOLERANCES ARE

MORETHANALL
PCB CONNECTORS
Cable ASSEMBLIES

煜倫股份有限公司

www.morethanall.com

DRAWING BY CY

CHECKED BY GENIUS

UNIT / mm

SCALE 1:1

DATE

SIZE A4

X: ±
.X ± 0.25
.XX ± 0.15
.XXX ± 0.05
ANG ± 1°

PPOJECTION

照片框

ORDER INFORMATION

MISB-SWFXMM7171P40R-5B-LF
SERIES | | | | | LEADFREE
FEMALE | | | | | 5 PIN B TYPE
90°SMT | | | | | REEL
NON FLANGE | | | | | POST 4.0mm
METAL FOOT 7.15+7.15mm

DESCRIPTION: