

MATERIAL:

- 1.1 Housing: thermoplastic high temp. UL94V-0; Color: Black.
- 1.2 Terminal: Copper Alloy.
- 1.3 Shell: Stainless Steel.

ELECTRICAL:

- 2.1 Current rating: 1.0A(2,3,4p) 1.8A(1,5p)
- 2.2 Voltage: 30VDC Max.
- 2.3 Contact resistance: 30 milliohms Max.
- 2.4 Insulation resistance: 1000 Megohms Min.
- 2.5 Withstanding voltage: 100V AC/Minute.
- 2.6 Temperature range: -25°C to +85°C.

RoHS Compliant

TOLERANCES ARE



DRAWING BY CY		X ±
CHECKED BY GENIUS		.X ± 0.30
UNIT / mm		.XX ± 0.20
SCALE 1 : 1		.XXX ± 0.10
DATE		ANG ±

煜倫股份有限公司

www.morethanall.com

SIZE A4 PPROJECTION



ORDER INFORMATION

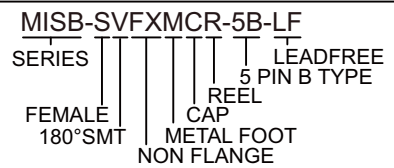

DESCRIPTION: Micro USB 5Pin Female SMT VERTICAL TYPE

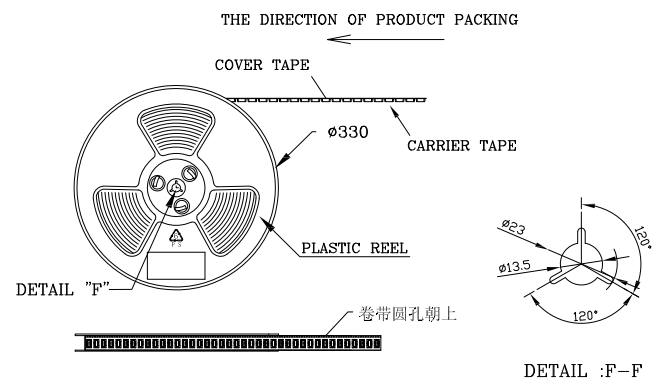
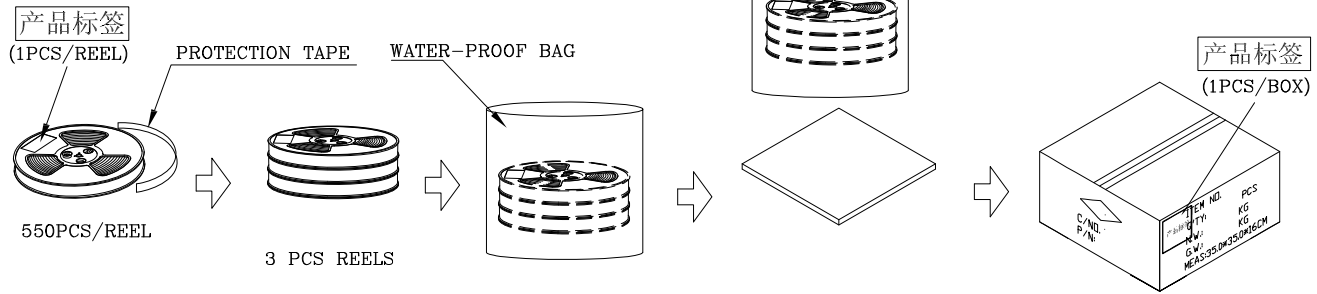
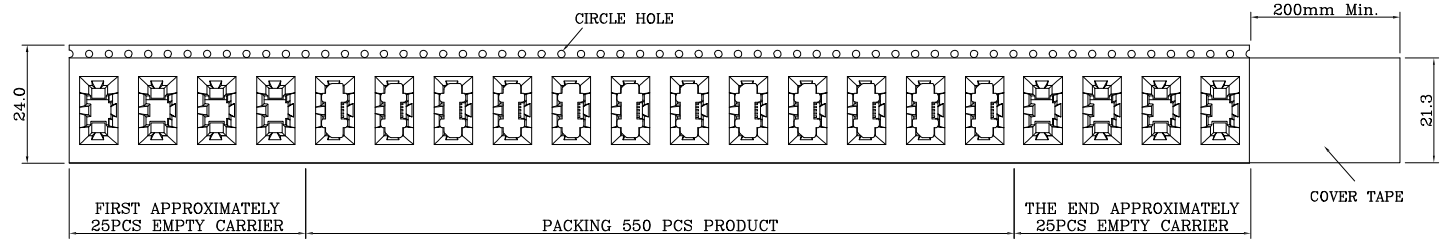
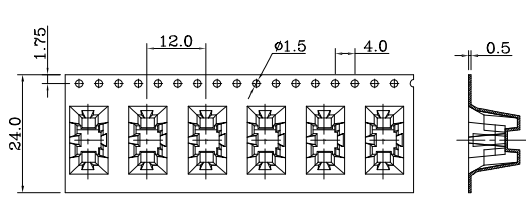

Note:
 1. Peeling Off Force Of Top Tape: 0.1-1.3N
 (Peeling Direction As Shown in Following Fig.)
 This Requirement Should Be Applied At Shipment
 Peel Off Should Not Be Allowed, During Transportation.

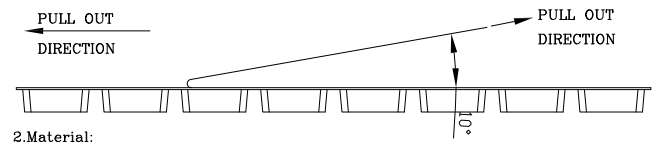

2. Material:
 Carrier Tape: Polystyren(PS)
 Top Tape: PE
 Reel Tape: Polystyren(PS)

RoHS Compliant

TOLERANCES ARE

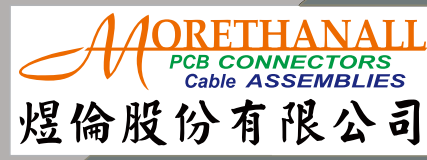

DRAWING BY CY		X, ±
CHECKED BY GENIUS		.X ± 0.30
UNIT / mm	SCALE 1 : 1	.XX ± 0.20
DATE		.XXX ± 0.10
SIZE A4	PPOJECTION	ANG ±



ORDER INFORMATION

MISB-SVFXMCR-5B-LF
 SERIES | | | | | LEADFREE
 | | | | | 5 PIN B TYPE
 FEMALE | | | | REEL
 180°SMT | | | | CAP
 | | | | METAL FOOT
 | | | | NON FLANGE

DESCRIPTION: Micro USB 5Pin Female SMT VERTICAL TYPE