

Specifications:
 Current Rating:1.0A AC/DC
 Voltage Rating:30V AC/DC
 Contact Resistance:20m ohm. Max.
 Insulation Resistance:1000M ohm. Min.
 Withstanding Voltage:500V AC For One Minute
 Operating Temperature Range:-40°C ~ +105°C
 Material and Finish
 Insulator:High Temp. Plastic (UL94V-0)
 Contact:Copper Alloy
 Finish:Tin Plated

| Circuits | Dimension | | Circuits | Dimension | |
|----------|-----------|-------|----------|-----------|-------|
| | A | B | | A | B |
| 4 | 8.45 | 2.54 | 16 | 23.69 | 17.78 |
| 6 | 10.99 | 5.08 | 18 | 26.23 | 20.32 |
| 8 | 13.53 | 7.62 | 20 | 28.77 | 22.86 |
| 10 | 16.07 | 10.16 | 22 | 31.31 | 25.40 |
| 12 | 18.61 | 12.70 | 24 | 33.85 | 27.94 |
| 14 | 21.15 | 15.24 | 26 | 36.39 | 30.48 |

MIM-BCR-xx-LF
 LEADFREE

RoHS Compliant

MORETHANALL
 CONNECTORS
 ASSEMBLIES

煜倫股份有限公司

PART NO. MIM-BCR-xx

DWG NO. MIM-BCR-xx

FILE NO.

UNIT / mm

SCALE 1:1

CHECKED BY CY

DRAWING BY

PROJECTION

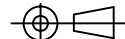

TOLERANCES ARE

.X ± 0.2
 .XX ± 0.1
 .XXX ±
 AWG

DESCRIP TION:

2.54mm IDC Connector Male
 On Wire Type

AREA

REVISIONS

HK

DATE

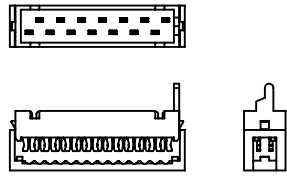

MIM-BCR-xx

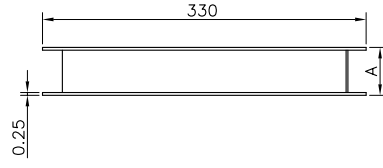

Note:

- 1.All dimensions meet EIA-481-3 requirements.
- 2.Material : Black Conductive Polystyrene Alloy
100% recyclable.
- 3.Thickness : 0.40±0.05mm
- 4.Component load per 13" reel :700 pcs.
- 5.CARTON SIZE:350*350*296(MM)

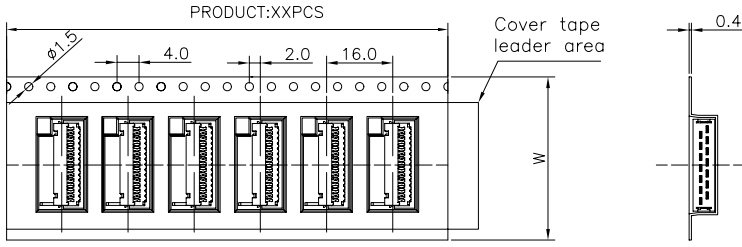

For Reel width (dimension W)16,24mm ,Single row hole

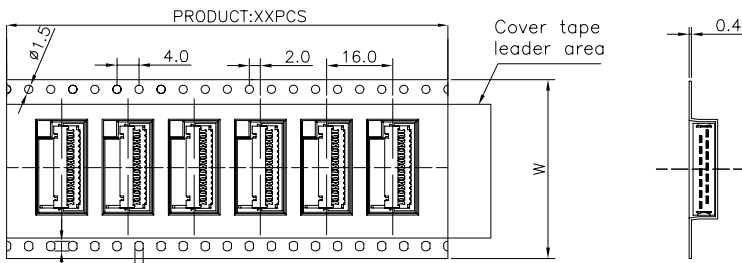

For Reel width (dimension W)32,44,56,72mm ,Double rows hole

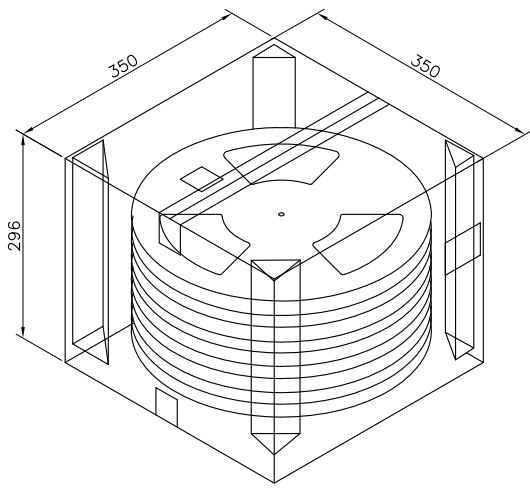
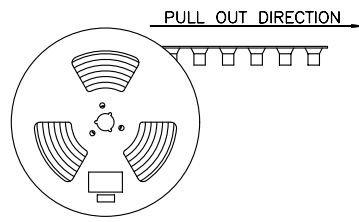

| Pin No | W | A | PCS/R | R/CTN | Q'TY |
|--------|----|----|-------|-------|------|
| 04 | 16 | 21 | 700 | 12 | 8400 |
| 06 | 24 | 29 | 700 | 9 | 6300 |
| 08 | 24 | 29 | 700 | 9 | 6300 |
| 10 | 32 | 37 | 700 | 7 | 4900 |
| 12 | 32 | 37 | 700 | 7 | 4900 |
| 14 | 44 | 49 | 700 | 5 | 3500 |
| 16 | 44 | 49 | 700 | 5 | 3500 |
| 18 | 44 | 49 | 700 | 5 | 3500 |
| 20 | 44 | 49 | 700 | 5 | 3500 |
| 22 | 44 | 49 | 700 | 5 | 3500 |
| 24 | 56 | 61 | 700 | 4 | 2800 |
| 26 | 56 | 61 | 700 | 4 | 2800 |

MORETHANALL
CONNECTORS
ASSEMBLIES

PART NO. MIM-BCR-xx

DWG NO. MIM-BCR-xx

CHECKED BY CY

TOLERANCES ARE

DESCRIPTION:

2.54mm IDC Connector Male On Wire Type Packing list

FILE NO.

DRAWING BY

.X ± 0.2
.XX ±
.XXX ±
AWG

AREA

REVISIONS

HK

DATE

煜倫股份有限公司

UNIT / mm

SCALE 1:1

PROJECTION