

NOTES :  
 1. Material :  
 Housing : High temperature thermoplastic, UL94-V0.  
 Color : Black  
 HDMI Terminal : Copper Alloy.  
 Cover : Copper Alloy.  
 2. Finish :  
 Terminal : Underplate : Ni 50  $\mu$ " MIN. over all.  
 Sn $\mu$ "100 MIN Solder tail  $\mu$ "Sn100 MIN Lead free over Ni plate.  
 Contact arer: Au over Ni plate  
 Cover : Underplate :50  $\mu$ " MIN. Ni over all.  
 over Ni .  
 3. Coplanarity Must Be Within 0.12 Max.

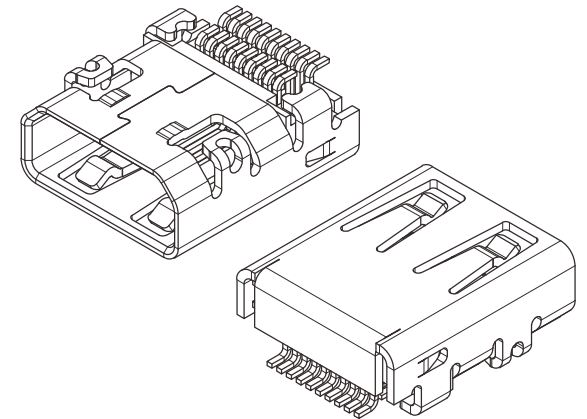

RoHS Compliant

TOLERANCES ARE

**MORETHANALL**  
 PCB CONNECTORS  
 Cable ASSEMBLIES

DRAWING BY CY

X.  $\pm$

CHECKED BY GENIUS

.X  $\pm$

UNIT / mm

SCALE 1 : 1

.XX  $\pm$

DATE

.XXX  $\pm$

ANG  $\pm$

SIZE A4

PJECTION

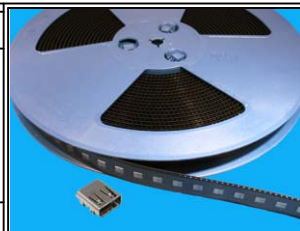

ORDER INFORMATION

MIHDMI-SWJJR-19-LF

SERIES

LEADFREE

19 WAY

REEL

JJ TYPE

90°SMT

FEMALE

煜倫股份有限公司

www.morethanall.com

DESCRIPTION:

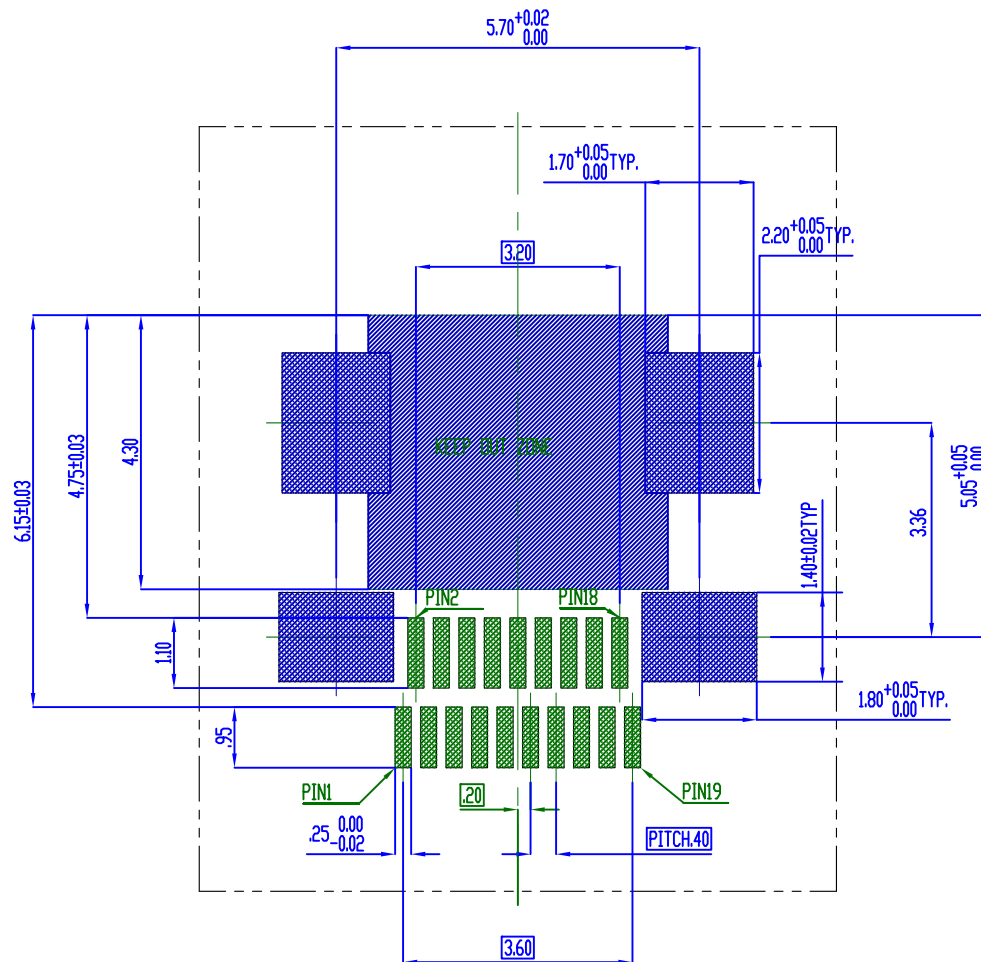

Recommend PCB Layout Tolerance = +/- 0.02 mm



HDMI Each Signal Terminal  
Will Be Functional After Detected.

| 19             | 5V Power          |
|----------------|-------------------|
| 18             | SDA               |
| 17             | SCL               |
| 16             | DDC/CEC Ground    |
| 15             | CEC               |
| 14             | TMDS Clock-       |
| 13             | TMDS Clock Shield |
| 12             | TMDS Clock+       |
| 11             | TMDS Data0-       |
| 10             | TMDS Data0 Shield |
| 09             | TMDS Data0+       |
| 08             | TMDS Data1-       |
| 07             | TMDS Data1 Shield |
| 06             | TMDS Data1+       |
| 05             | TMDS Data2-       |
| 04             | TMDS Data2 Shield |
| 03             | TMDS Data2+       |
| 02             | Utility           |
| 01             | Hot Plug Detect   |
| Pin NO.        | Description       |
| Pin Assignment |                   |

RoHS Compliant

TOLERANCES ARE

**MORETHANALL**  
PCB CONNECTORS  
Cable ASSEMBLIES

DRAWING BY CY

X.±

CHECKED BY GENIUS

.X±

UNIT / mm

SCALE 1 : 1

.XX±

DATE

.XXX±

ANG±

SIZE A4

P PROJECTION

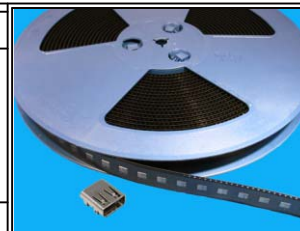

ORDER INFORMATION

MIHDMI-SWJJR-19-LF

SERIES

LEADFREE

19 WAY

REEL

JJ TYPE

90°SMT

FEMALE

煜倫股份有限公司

www.morethanall.com

DESCRIPTION:

### 1. Tape Packed Status

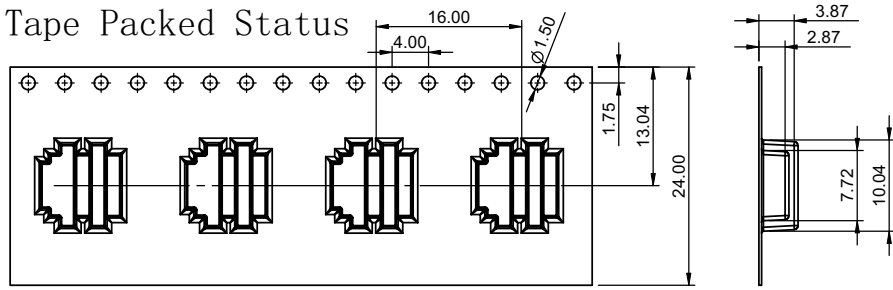

### 3. Carton Containing 8 Reel (See Chart A)

|   | Packing Quality |        |
|---|-----------------|--------|
|   | Reel            | Carton |
| A | 1000            | 8000   |

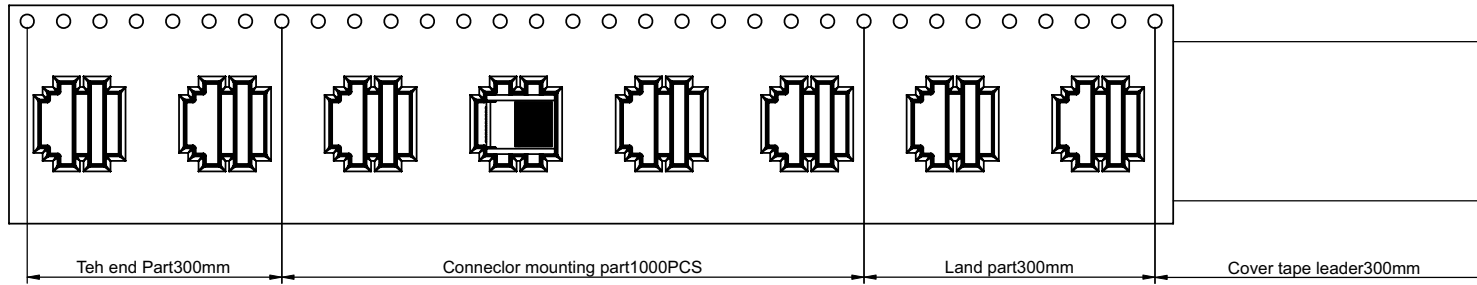
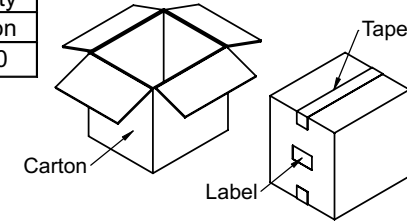

### 2. Reel Packed Status

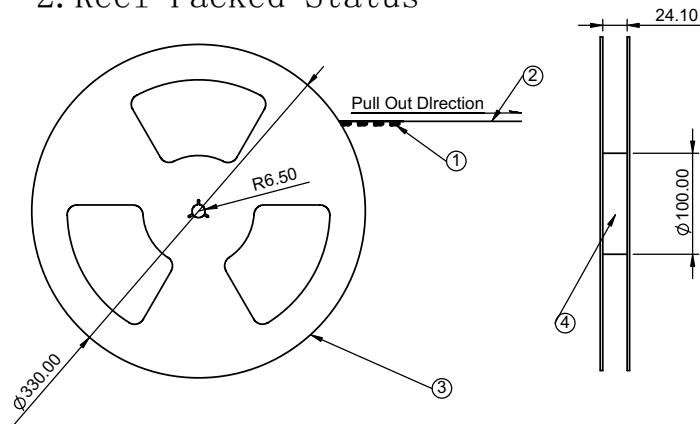

| ITEM | NAME         | MATERIAL | COLOR       |
|------|--------------|----------|-------------|
| 1    | CARRIER TAPE | PS       | BLACK       |
| 2    | COVER        | PE       | TRANSLUCENT |
| 3    | REEL PLATE   | PS       | BLUE        |
| 4    | REEL CORE    | PS       | BLUE        |

**RoHS Compliant**

TOLERANCES ARE

**MORETHANALL**  
PCB CONNECTORS  
Cable ASSEMBLIES

DRAWING BY CY

X, ±

CHECKED BY GENIUS

.X ±

UNIT / mm

SCALE 1 : 1

.XX ±

DATE

.XXX ±

ANG ±

SIZE A4

PJECTION

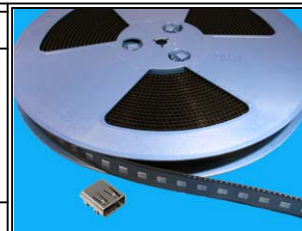

**ORDER INFORMATION**

MIHDMI-SWJJR-19-LF

SERIES

LEADFREE

19 WAY

REEL

JJ TYPE

90°SMT

FEMALE

煜倫股份有限公司

www.morethanall.com

DESCRIPTION: