

MHC-W22H44-601-LF
LEADFREE
RoHS Compliant

MORETHANALL
CONNECTORS
ASSEMBLIES

PART NO. MHC-W22H44-601

DWG NO. MHC-W22H44-601

FILE NO.

UNIT / mm

SCALE 1:1

CHECKED BY CY

DRAWING BY

PROJECTION

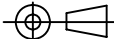

TOLERANCES ARE

.X ± 0.2

.XX ±

.XXX ±

AWG

DESCRIPTION:

SD/MMC(&4.0)/MIN SD
RS MMC(&4.0) 6 IN 1 CONN.

AREA

REVISIONS

HK

DATE

焯倫股份有限公司

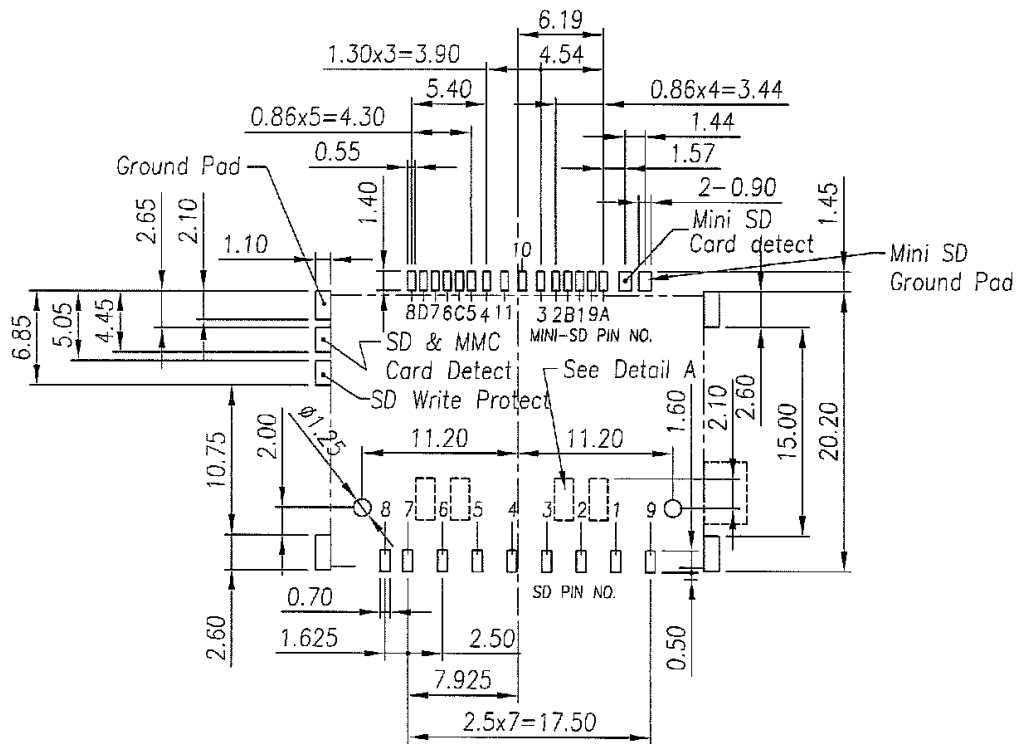

P.C.B Layout (Top View)

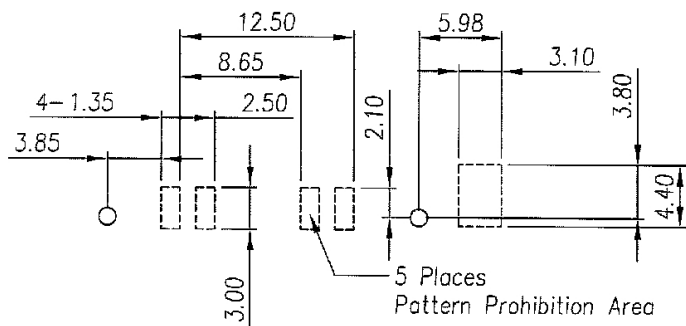

Detail A

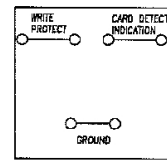

WITHOUT CARD

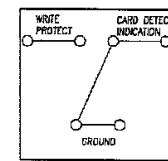

CARD INSERTED
WRITE PROTECT : LOCK

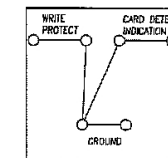

CARD INSERTED
WRITE PROTECT : UNLOCK

SD		MINI-SD		MMC 4.0	
PIN	NAME	PIN	NAME	PIN	NAME
1	CD/DAT3	1	CD/DAT3	A	DAT4
2	COMD/DI	2	COMD/DI	B	DAT5
3	VSS1	3	VSS1	C	DAT6
4	VDD	4	VDD	D	DAT7
5	CLK/SCLK	5	CLK/SCLK		
6	VSS2	6	VSS2		
7	DAT0	7	DAT0		
8	DAT1	8	DAT1		
9	DAT2	9	DAT2		

MORETHANALL
CONNECTORS
ASSEMBLIES

PART NO. MHC-W22H44-601

DWG NO. MHC-W22H44-601

FILE NO.

UNIT / mm

SCALE 1:1

CHECKED BY CY

DRAWING BY

PROJECTION

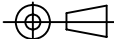

TOLERANCES ARE

.X ± 0.2

.XX ±

.XXX ±

AWG

DESCRIPTION:

AREA

REVISIONS

HK

DATE

煜倫股份有限公司