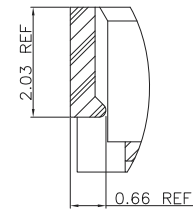
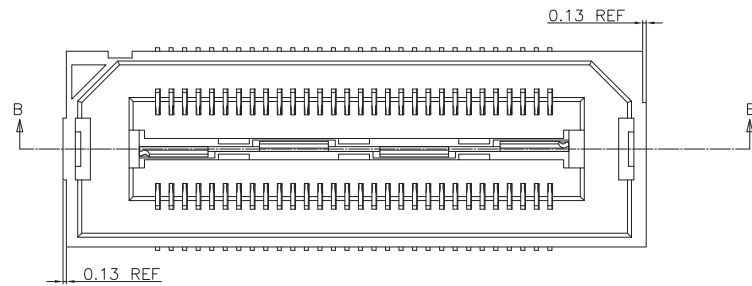

TABLE 3		
Pos.	Dimension	
	C	D
60	30.89	25.73
120	50.89	45.73
180	70.89	65.74
240	90.89	85.74
300	110.90	105.74

(Guides Pin) SAME AS SHEET 1, EXCEPT AS SHOWN



DETAIL A
SCALE 8:1

(Friction Lock)
SAME AS SHEET 1, EXCEPT AS SHOWN
Not Available with -G(Guides Pin) Options

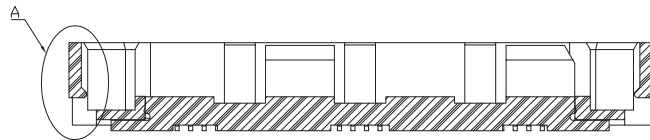

SECTION B-B
SCALE 4:1



煜倫股份有限公司

www.morethanall.com

RoHS Compliant

DRAWING BY CY

CHECKED BY GENIUS

UNIT / mm

SCALE 1:1

DATE

SIZE A4

TOLERANCES ARE

X ± 0.50

.X ± 0.25

.XX ± 0.15

.XXX ±

ANG ±

PJECTION

照片框

ORDER INFORMATION

HSNP0560-S010PF-xxx-LF

SERIES

LEADFREE
060~300WAY
FLANGE
POST
UNMATED HIGH 1.0mm
FEMALE

DESCRIPTION: High Speed Board to Board Pitch 0.5mm(Socket)

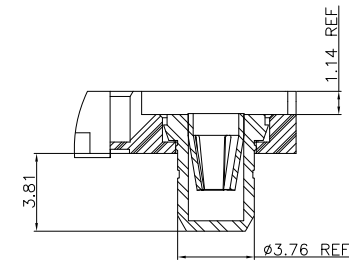
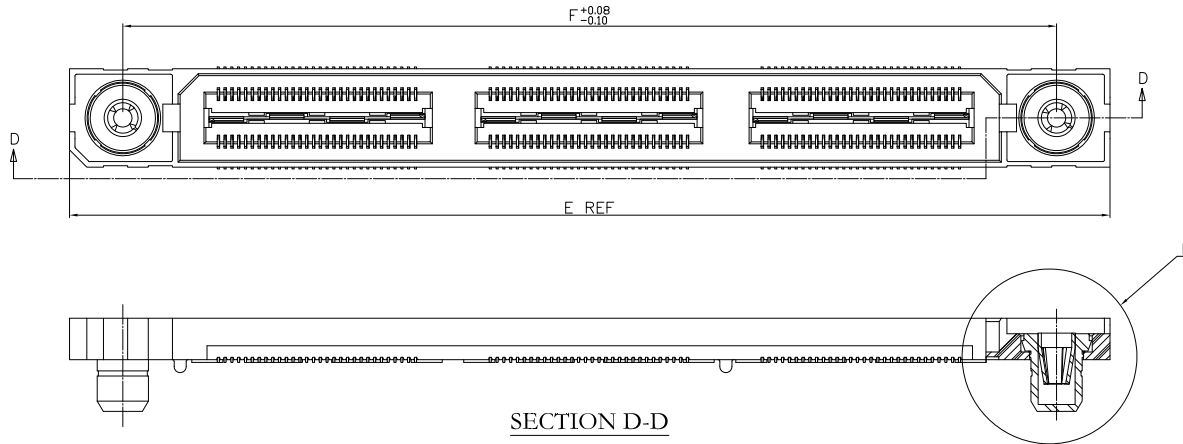

POS	E	F
60	36.51	28.66
120	56.52	48.67
180	76.52	68.67
240	N/A	N/A
300	N/A	N/A

DETAIL E
SCALE 3:1

-P1(Up & Down Post and P) SAME AS SHEET 1, EXCEPT AS SHOWN
(FOR -P STYLE ONLY)
(Not Available with -L,-G,or -F Options)
(Not Available With -240 & -300 POS)

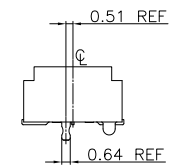
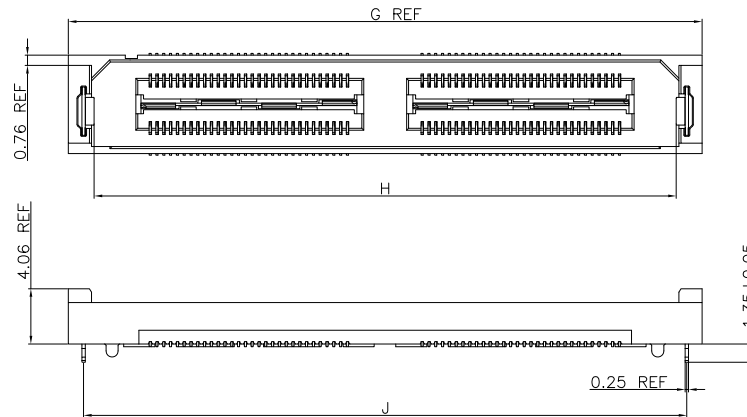

POS	G	H	J
60	26.61	22.78	24.36
120	46.61	42.78	44.36
180	66.61	62.78	64.36

-L1(With Lock) SAME AS SHEET 1, EXCEPT AS SHOWN
(Not Available with -L,-G,-F,or -P1 Options)
(Not Available With -180,-240 & -300 POS)

RoHS Compliant

TOLERANCES ARE

MORETHANALL
PCB CONNECTORS
Cable ASSEMBLIES

煜倫股份有限公司

www.morethanall.com

DRAWING BY CY

CHECKED BY GENIUS

UNIT / mm

SCALE 1 : 1

DATE

SIZE A4

X. ± 0.50

.X ± 0.25

.XX ± 0.15

.XXX ±

ANG ±

PJECTION

照片框

ORDER INFORMATION

HSNP0560-S010PF-xxx-LF

SERIES

LEADFREE
060~300WAY
FLANGE
POST
UNMATED HIGH 1.0mm
FEMALE

DESCRIPTION: High Speed Board to Board Pitch 0.5mm(Socket)

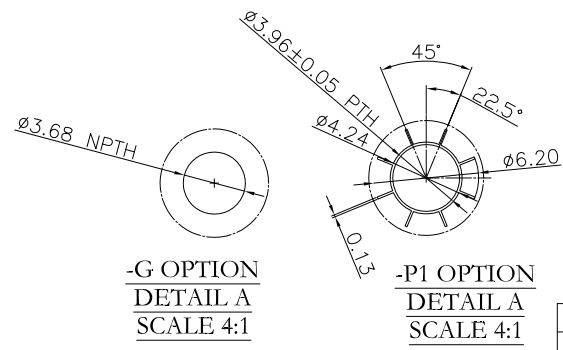
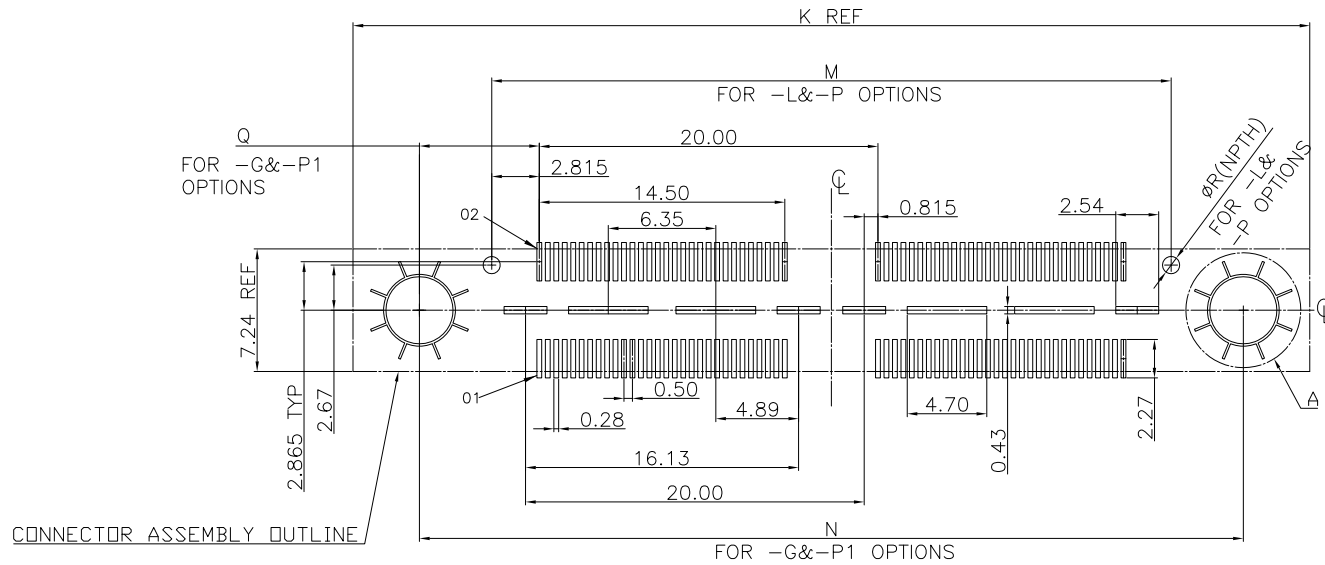

TABLE 7

OPTION	Q
-G	5.61
-P1	7.08

TABLE 8

OPTION	R
-L	1.19
-P	1.02

TABLE 6

POS	K			M	N		
	-L&P	-F	-G		-L&P	-G	-P1
60	21.31	20.38	30.89	36.53	20.13	25.73	28.68
120	41.31	40.39	50.89	56.53	40.13	45.73	48.68
180	61.38	60.39	70.89	76.53	60.13	65.74	68.68
240	81.38	80.39	90.89	N/A	80.14	85.74	N/A
300	101.37	100.39	110.90	N/A	100.14	105.74	N/A

P.C.Board Layout
(Tolerance:±0.05)

照片框

RoHS Compliant

TOLERANCES ARE

MORETHANALL
PCB CONNECTORS
Cable ASSEMBLIES

煜倫股份有限公司

www.morethanall.com

DRAWING BY	CY	X. ± 0.50
CHECKED BY	GENIUS	.X ± 0.25
UNIT / mm	SCALE 1 : 1	.XXX ±
DATE		ANG ±
SIZE A4	PJECTION	

ORDER INFORMATION

HSNP0560-S010PF-xxx-LF

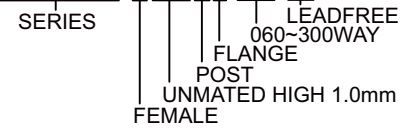

DESCRIPTION: High Speed Board to Board Pitch 0.5mm(Socket)

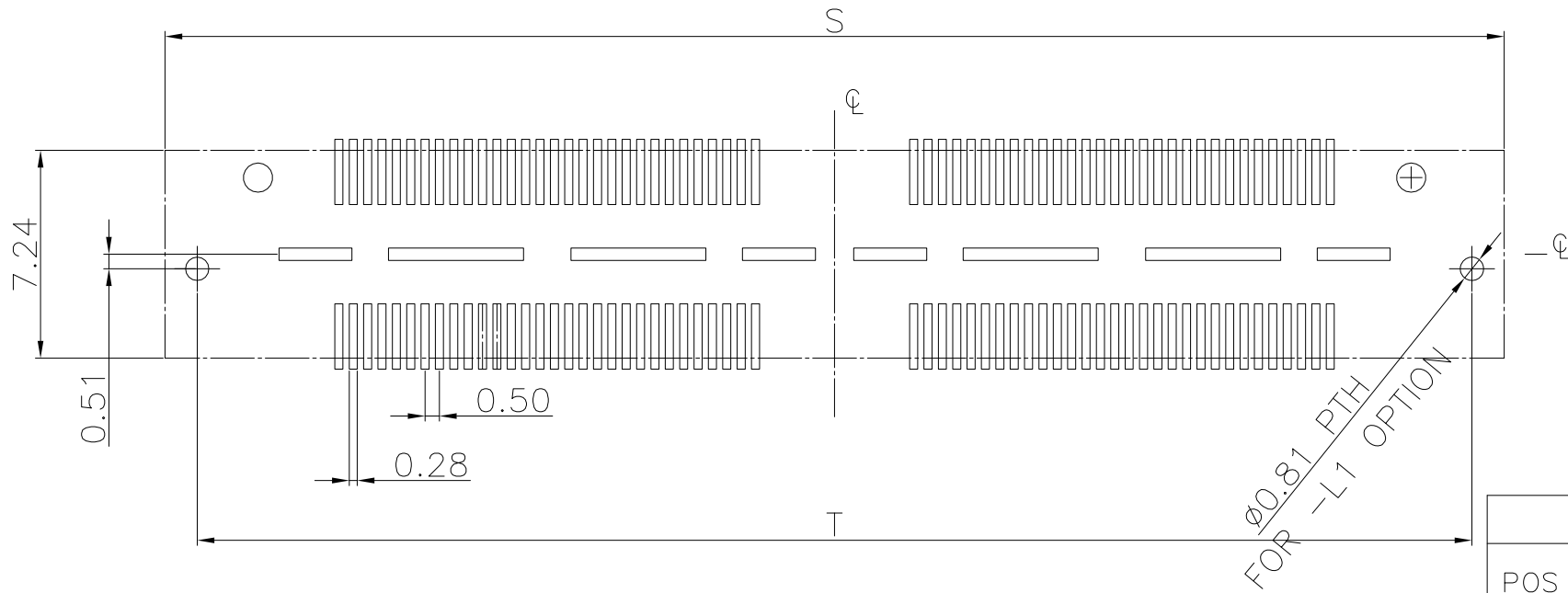

P.C.Board Layout
(Tolerance:±0.05)

TABLE 9		
POS	S	T
60	26.62	24.36
120	46.62	44.36
180	66.62	64.36
240	86.62	84.37
300	106.63	104.37

RoHS Compliant

TOLERANCES ARE

MORETHANALL
PCB CONNECTORS
Cable ASSEMBLIES

DRAWING BY CY

X. ± 0.50

CHECKED BY GENIUS

.X ± 0.25

UNIT / mm

SCALE 1:1

.XX ± 0.15

DATE

.XXX ±

ANG ±

照片框

ORDER INFORMATION

HSNP0560-S010PF-xxx-LF

SERIES

LEADFREE
060~300WAY
FLANGE
POST
UNMATED HIGH 1.0mm
FEMALE

煜倫股份有限公司

www.morethanall.com

SIZE A4

P PROJECTION

DESCRIPTION: High Speed Board to Board Pitch 0.5mm(Socket)