

Material and Plating:

Housing: LCP, UL94V-0, Black.
 Signal Contacts: Phosphor Bronze.
 Gold Plated on Contact Area and 80u" Min Tin Plated on Solder Tail over nickel 50u" Min.
 Ground Contacts: Phosphor Bronze.
 Gold Plated on Contact Area and 80u" Min Tin Plated on Solder Tail over nickel 50u" Min.

Electrical Characteristics:

Current Rating: Signal: 3A Per Contact With 3 Adjacent Contacts (UL),
 Ground: 25A Per Contact With 1 Contact.

Voltage Rating: 125V AC.
 Dielectric Withstanding Voltage: 525V AC For 1 minute.
 Insulator Resistance: 5000MΩ min at DC 500V.

Contact Resistance: Signal: 45mΩ max.
 Ground: 15mΩ max.

Operating Temperature: -55°C ~ +125°C.

Durability: 250 Cycle.
 *RoHS Compliant

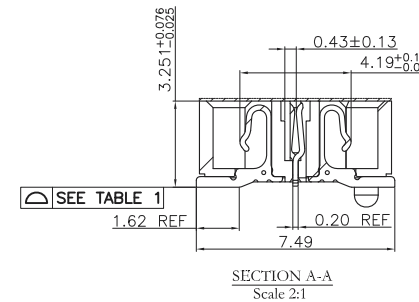
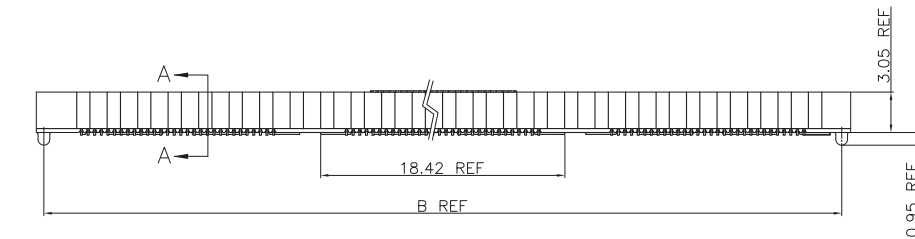

TABLE 2		
Pos.	Dimension	
	A	B
60	21.31	20.13
120	41.31	40.13
180	61.38	60.13
240	81.38	80.14
300	101.37	100.14

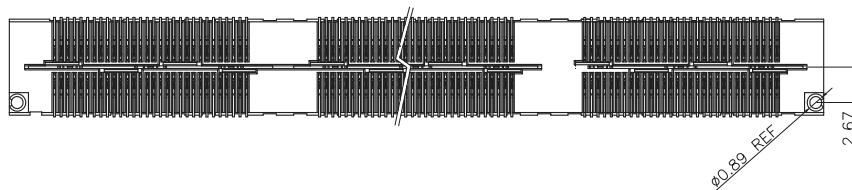

TABLE 1	
NO OF POSITIONS	COPLANARITY (INCLUDING GP)
-60 THRU -120	0.10
-180 & -300	0.15
Signaling (5mm Stack Height)	Speed Rating (No PCB Effect)
Single-Ended	9.5GHz/19Gbps
Differential	10.5GHz/21Gbps

Note :

"1":With Contact
 "0":Without Contact

PIN	02	04	06	08	10	12	14	16	18	20	22	24	26	28	30	32	34	36	38	40	42	44	46	48	50	52	54	56	58	60
PIN	01	03	05	07	09	11	13	15	17	19	21	23	25	27	29	31	33	35	37	39	41	43	45	47	49	51	53	55	57	59
	1	1	1	1	1	1	1	1	1	1	1	1	1	1	1	1	1	1	1	1	1	1	1	1	1	1	1	1	1	1
PIN	62	64	66	68	70	72	74	76	78	80	82	84	86	88	90	92	94	96	98	100	102	104	106	108	110	112	114	116	118	120
PIN	61	63	65	67	69	71	73	75	77	79	81	83	85	87	89	91	93	95	97	99	101	103	105	107	109	111	113	115	117	119
	1	1	1	1	1	1	1	1	1	1	1	1	1	1	1	1	1	1	1	1	1	1	1	1	1	1	1	1	1	
PIN	122	124	126	128	130	132	134	136	138	140	142	144	146	148	150	152	154	156	158	160	162	164	166	168	170	172	174	176	178	180
PIN	121	123	125	127	129	131	133	135	137	139	141	143	145	147	149	151	153	155	157	159	161	163	165	167	169	171	173	175	177	179
	1	1	1	1	1	1	1	1	1	1	1	1	1	1	1	1	1	1	1	1	1	1	1	1	1	1	1	1	1	

RoHS Compliant

TOLERANCES ARE

MORETHANALL
 PCB CONNECTORS
 Cable ASSEMBLIES

DRAWING BY CY

X. ± 0.50

CHECKED BY GENIUS

.X ± 0.25

UNIT / mm

SCALE 1 : 1

.XXX ±

DATE

ANG ±

SIZE A4

PJECTION

照片框

ORDER INFORMATION

HSNP0560-S010PC-xxx-LF

SERIES

LEADFREE

060~300WAY

MYLAR

POST

UNMATED HIGH 1.0mm

FEMALE

煜倫股份有限公司

www.morethanall.com

DESCRIPTION: High Speed Board to Board Pitch 0.5mm(Socket)

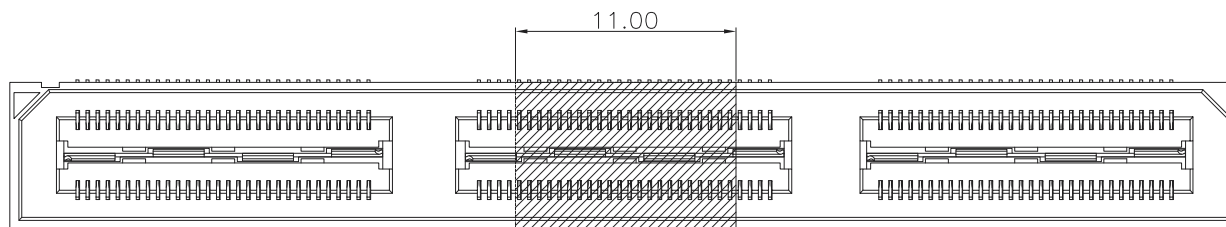
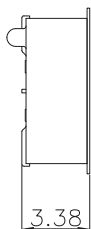

Mylar



RoHS Compliant

TOLERANCES ARE

MORETHANALL
PCB CONNECTORS
Cable ASSEMBLIES

DRAWING BY CY

X. ± 0.50

CHECKED BY GENIUS

.X ± 0.25

UNIT / mm

SCALE 1 : 1

.XX ± 0.15

DATE

.XXX ±

ANG ±

煜倫股份有限公司

www.morethanall.com

SIZE A4

PJECTION

ORDER INFORMATION

HSNP0560-S010PC-xxx-LF

SERIES

LEADFREE

060~300WAY

MYLAR

POST

UNMATED HIGH 1.0mm

FEMALE

DESCRIPTION: High Speed Board to Board Pitch 0.5mm(Socket)

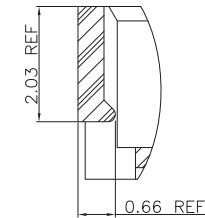
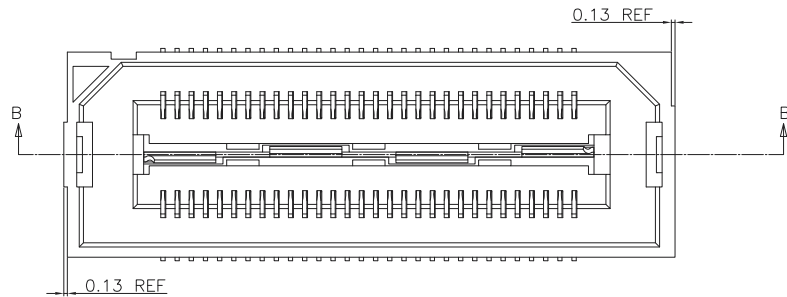

DETAIL A
SCALE 8:1

-F(Friction Lock)
SAME AS SHEET 1, EXCEPT AS SHOWN
Not Available with -G(Guides Pin) Options

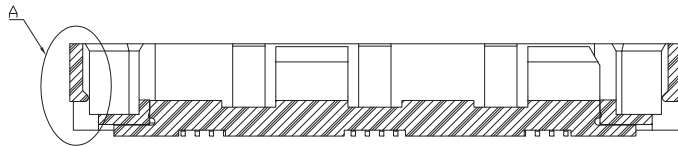

SECTION B-B
SCALE 4:1

RoHS Compliant

TOLERANCES ARE

MORETHANALL
PCB CONNECTORS
Cable ASSEMBLIES

DRAWING BY CY

X. ± 0.50

CHECKED BY GENIUS

.X ± 0.25

UNIT / mm

SCALE 1:1

.XX ± 0.15

DATE

.XXX ±

ANG ±

照片框

ORDER INFORMATION

HSNP0560-S010PC-xxx-LF

SERIES

LEADFREE

060~300WAY

MYLAR

POST

UNMATED HIGH 1.0mm

FEMALE

煜倫股份有限公司

www.morethanall.com

SIZE A4

PPOJECTION

DESCRIPTION: High Speed Board to Board Pitch 0.5mm(Socket)