

CONNECTOR BODY

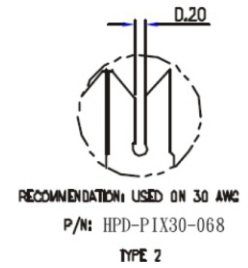

DETAIL A
SCALE: 10 : 1

TERMINATION COVER

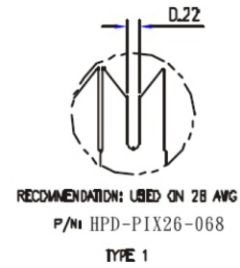
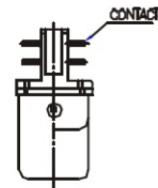
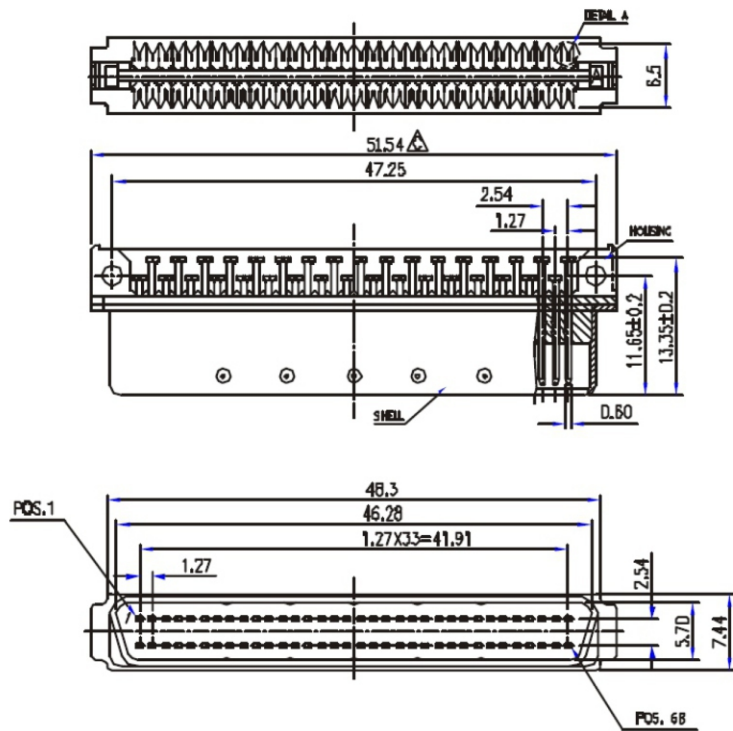
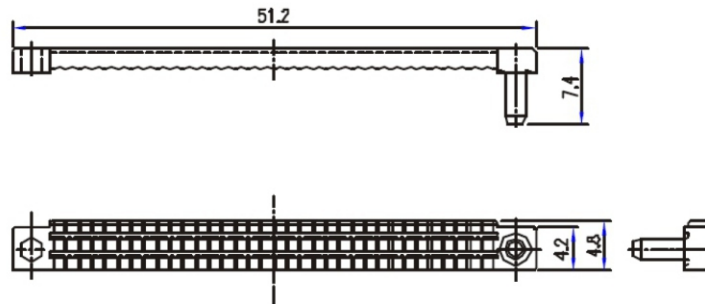

MORETHANALL
PCB CONNECTORS
Cable ASSEMBLIES
煜倫股份有限公司
www.morethanall.com

RoHS Compliant

DRAWING BY CY
CHECKED BY GENIUS
UNIT / mm SCALE 1 : 1
DATE
SIZE A4

TOLERANCES ARE

X, ±
.X ±
.XX ±
.XXX ±
ANG ±

PJECTION

照片框

ORDER INFORMATION

HPD-PIxx-068-LF
SERIES | LEADFREE
68 WAY
28:28 AWG
30:30 AWG
IDC
MALE

DESCRIPTION:

NOTE:

1.0 SPECIFICATIONS:

- 1.1 CONTACT CURRENT RATING: 1.0 AMPERES
- 1.2 DIELECTRIC WITHSTANDING VOLTAGE: AC 500 VOLTAGE R.M.S
- 1.3 HOUSING RESISTANCE: 1,000 MEGOHMS MINIMUM
- 1.4 CONTACT RESISTANCE: 35 MILLIOHMS MAXIMUM
- 1.5 OPERATING TEMPERATURE: -55°C TO +105°C

2.0 MATERIALS:

- 2.1 HOUSING: THERMOPLASTIC, GLASS-FIBER FILLED IN, UL 94V-0 RATED, COLOR TO BE BLACK
- 2.2 CONTACT: PHOSPHOR BRONZE
- 2.3 SHELL: STEEL
- 2.4 TERMINATION COVER: THERMOPLASTIC, GLASS-FIBER FILLED IN, UL 94V-0 RATED, COLOR TO BE BLACK

3.0 FINISH:

- 3.1 CONTACT: SELECTIVE GOLD PLATING
- 3.2 SHELL: NICKEL OVER COPPER

4.0 OTHERS:

- 4.1 RECOMMENDED WIRE: 28 AWG OR 30 AWG, SOLID OR 7 STRAND, WITH A INSULATION DIAMETER FROM 0.74-0.91 mm.
- 4.2 TERMINATING COVERS ARE PACKAGED SEPARATELY.

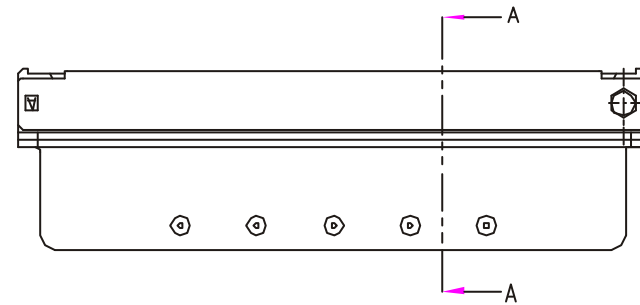

ASSEMBLY
SCALE 2:1

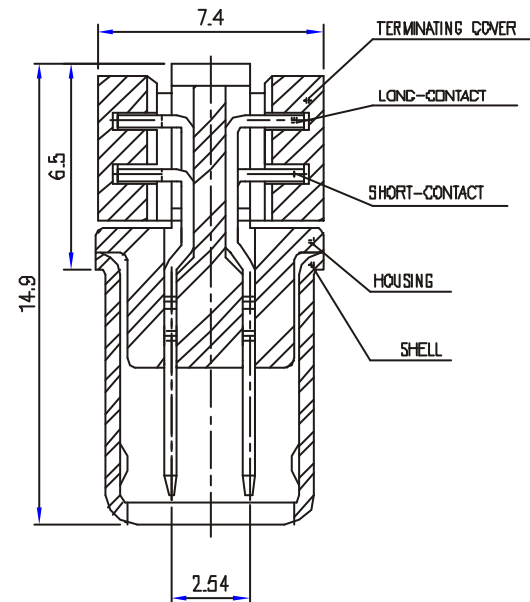

SECTION A-A
SCALE 5:1

RoHS Compliant

TOLERANCES ARE

MORETHANALL
PCB CONNECTORS
Cable ASSEMBLIES

煜倫股份有限公司

www.morethanall.com

DRAWING BY CY

CHECKED BY GENIUS

UNIT / mm SCALE 1:1

DATE

SIZE A4

X. ±
.X ±
.XX ±
.XXX ±
ANG ±

PROJECTION

照片框

ORDER INFORMATION

HPD-Plxx-068-LF
SERIES | LEADFREE
68 WAY
28:28 AWG
30:30 AWG
IDC
MALE

DESCRIPTION: HALF-PITCH PIN TYPE SERIES, 68 PDS. CABLE PLUG CONNECTOR