

NOTE:
 1.MATERIAL:
 HOUSING/CAP: THERMOPLASTIC UL 94V-0 BLACK
 TERMINAL: COPPER ALLOY
 SHELL: COPPER ALLOY
 2.PLATING:
 TERMINAL: CONTACT AREA PLATING: GOLD FLASH
 SOLDER AREA PLATING: MATING Sn 80u"Min
 UNDER AREA PLATING: Ni 50u"MIN
 SHELL: OVER AREA PLATING: Ni 40u"
 3.PACKAGE: TRAY

RoHS Compliant

TOLERANCES ARE

MORETHANALL
 PCB CONNECTORS
 Cable ASSEMBLIES

DRAWING BY CY

CHECKED BY GENIUS

UNIT / mm

SCALE 1 : 1

DATE

SIZE A4

P PROJECTION

X, ±
 .X ± 0.25
 .XX ± 0.15
 .XXX ± 0.05
 ANG ± 1°

照片框

ORDER INFORMATION

HDMI-SVM4C-19-LF
 SERIES | | | LEADFREE
 | | | 19WAY
 FEMALE | | | CAP
 | | | METAL FOOT x 4
 | | | 180°SMT

DESCRIPTION: HDMI-A F SMT 19PIN CONNECTOR (H=16.60)

煜倫股份有限公司

www.morethanall.com

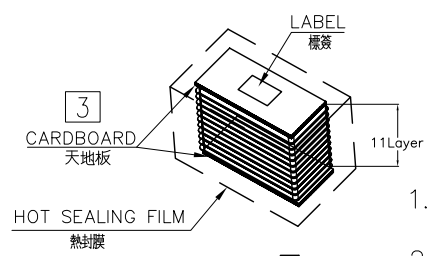
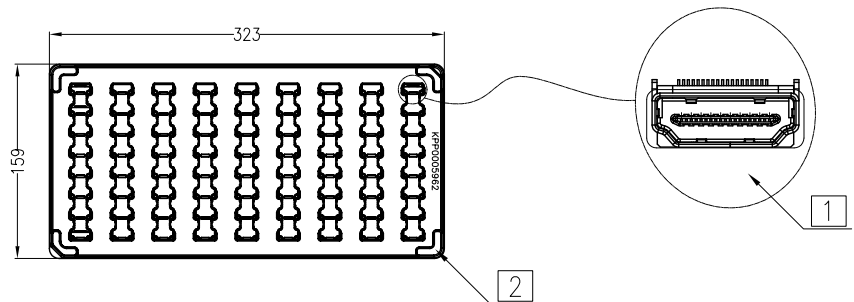

1. 裝滿產品的TRAY盤可疊10層，再頂層放置1PCS空盤，共11個盤子；
2. TRAY底部需放置一塊天地板，熱封後需在頂部貼上條碼標籤；

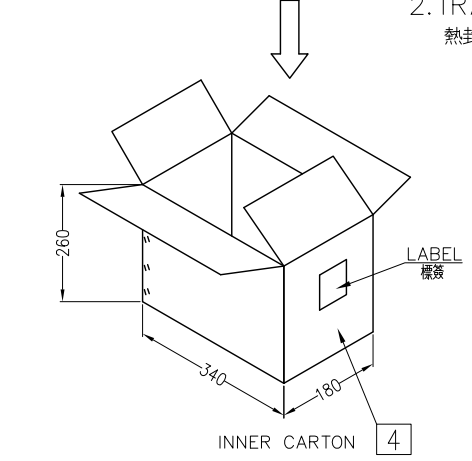

3. 內箱先放置一個PE防水袋，然後放入堆疊好的產品；
4. 10層/1內箱=72*10=720PCS；
5. 內箱需貼上條碼標籤；

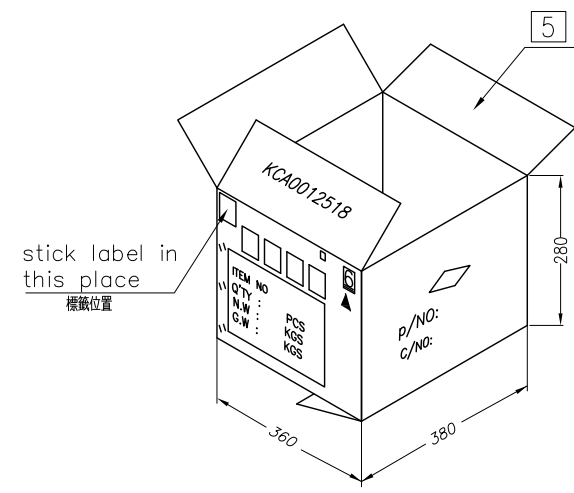
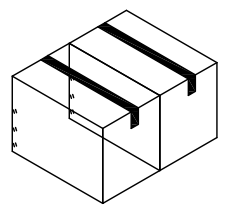

stick label in this place
標籤位置

OUTER CARTON

6. 2內箱/1外箱=720*2=1440PCS；
7. 用封箱膠封好外箱，貼上標籤，注意文字清晰。

NOTE:

序號 NO.	項 目 ITEM	
1	包裝方式 Method of packing	PCNTC001AC40-0
2	包裝方式說明 Packing instruction	TRAY
3	內包裝單位 Unit of inner packing	箱 CARTON
4	內包裝含產品數量 Inner packing quantity	720 PCS
5	長Length mm x 寬Width (mm) x 高 High (mm)	340x180x260
6	外包裝單位 Unit of outer packing	箱 CARTON
7	外包裝含內包裝數量 Quantity of inner packing	20
8	總數量 (PCS) Total quantity	1440 PCS
9	長Length (mm) x 寬Width (mm) x 高High (mm)	380x360x280
10	數量/盤 1. QUANTITY/tray	72 PCS
11	淨重/箱 WEIGHT/CARTON:N.W	5.06 KG
12	毛重/箱 WEIGHT/CARTON:G.W	6.80±0.30 KG

RoHS Compliant

TOLERANCES ARE

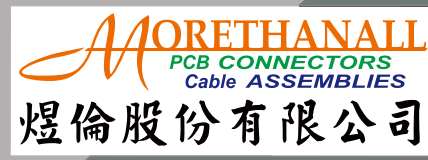

DRAWING BY CY		X. ± .X ± 0.25 .XX ± 0.15 .XXX ± 0.05 ANG ± 1°
CHECKED BY GENIUS		
UNIT / mm	SCALE 1 : 1	
DATE		
SIZE A4	P PROJECTION	

照片框

ORDER INFORMATION

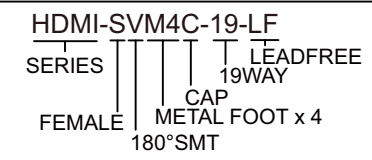

DESCRIPTION: HDMI-A F SMT 19PIN CONNECTOR (H=16.60)

www.morethanall.com