

Contract:

Contact: Brass.

Insulator: PBT.

Color: Black.

Contact Plated: Gold Over Nickel.

Solder Plated: Tin Over Nickel.

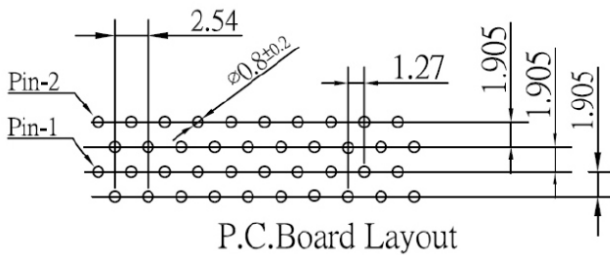

**HB-D4H10-xxx-LF**

**LEADFREE**

**RoHS Compliant**

Circuits	Dimension		
	A	B	C
16	8.89	18.66	16.46
20	11.43	21.20	19.00
32	19.05	28.82	26.62
40	24.13	33.90	31.70
44	26.67	36.44	34.24
52	31.75	41.52	39.32
60	36.83	46.60	44.40
68	41.91	51.68	49.48
80	49.53	59.30	57.10
100	62.23	72.00	69.80

**MORETHANALL**  
CONNECTORS  
ASSEMBLIES

PART NO. **HB-D4H10-xxx**

DWG NO. **HB-D4H10-xxx**

FILE NO.

UNIT / mm

SCALE 1:1

CHECKED BY CY

DRAWING BY

PROJECTION

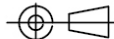

TOLERANCES ARE

.X ± 0.2

.XX ±

.XXX ±

AWG

DESCRIPTION:

AREA

REVISIONS

HK

DATE

焯倫股份有限公司

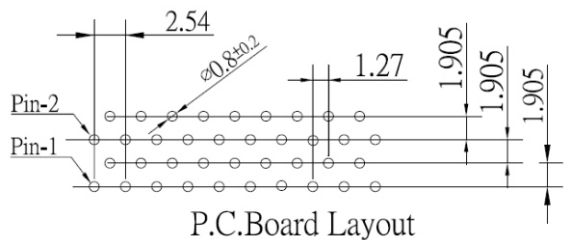
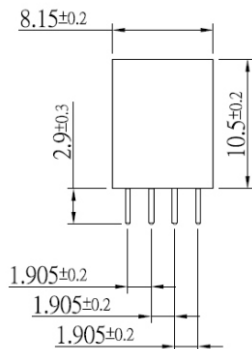
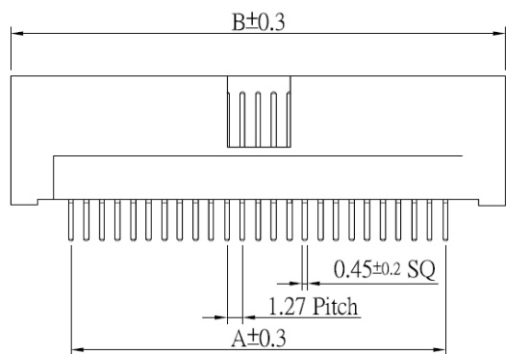
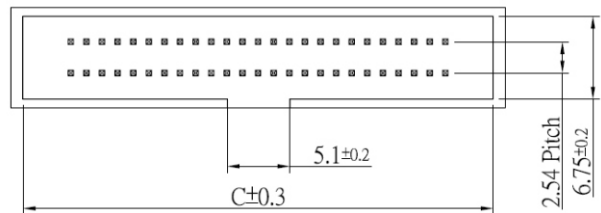
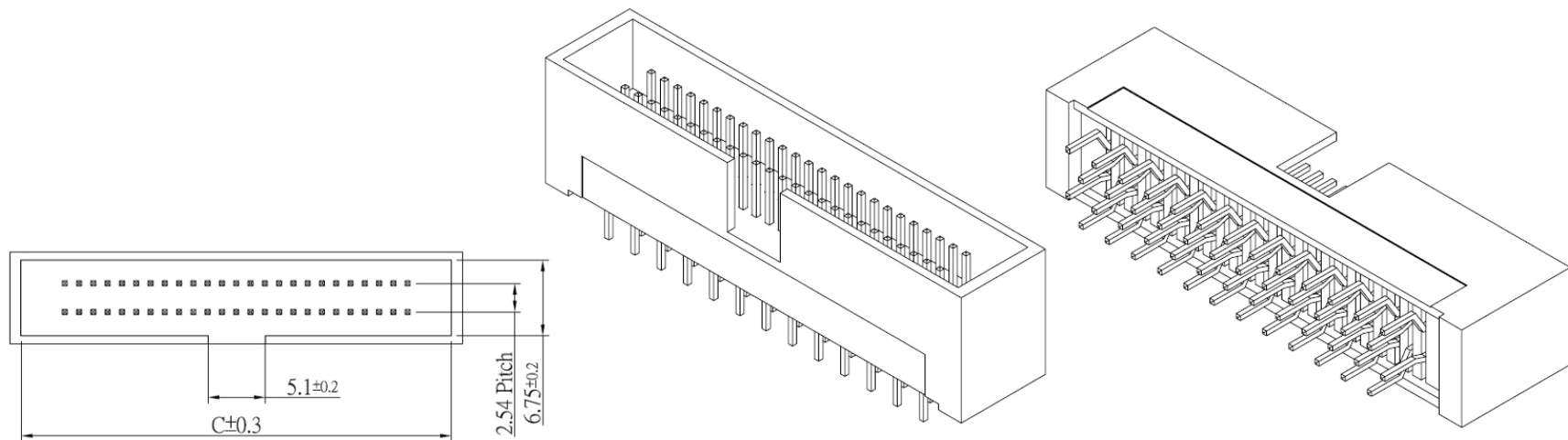

Contract:

Contact: Brass.

Insulator: PBT.

Color: Black.

Contact Plated: Gold Over Nickel.

Solder Plated: Tin Over Nickel.

Circuits	Dimension		
	A	B	C
10	5.08	14.85	12.65
26	15.24	25.01	22.81
30	17.78	27.55	25.35
34	20.32	30.09	27.89
50	30.48	40.25	38.05
70	43.18	52.95	50.75

**HB-D4H10-xxx-LF**

**LEADFREE**

**RoHS Compliant**

**MORE THAN ALL**  
CONNECTORS  
ASSEMBLIES

PART NO. **HB-D4H10-xxx**

DWG NO. **HB-D4H10-xxx**

FILE NO.

UNIT / mm

SCALE 1:1

CHECKED BY CY

DRAWING BY

PROJECTION

TOLERANCES ARE

.X ± 0.2

.XX ±

.XXX ±

AWG

DESCRIPTION:

AREA

REVISIONS

HK

DATE

**焜倫股份有限公司**