

A TYPE

端子高度PIN 0.10max

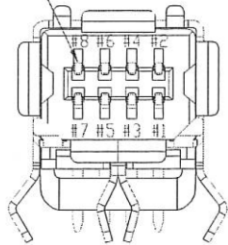

B TYPE

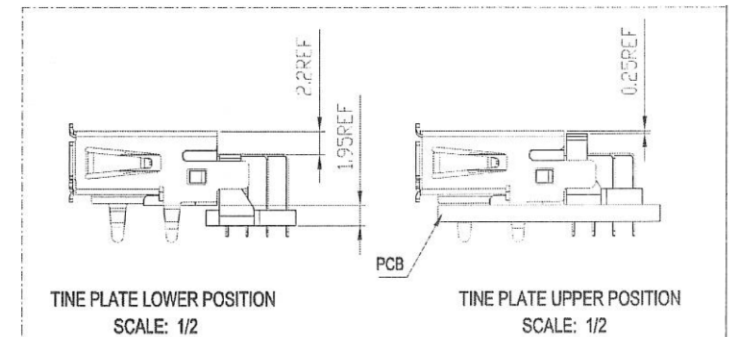
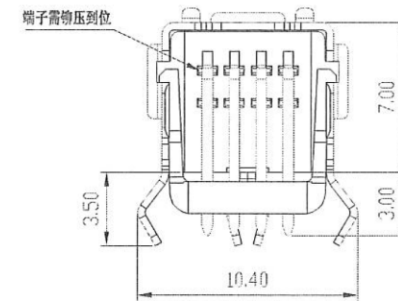
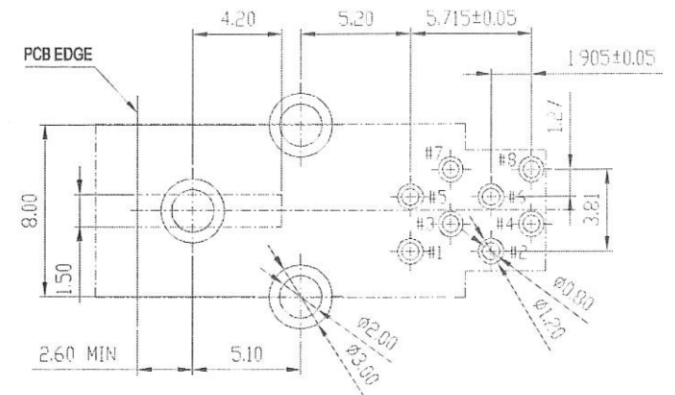
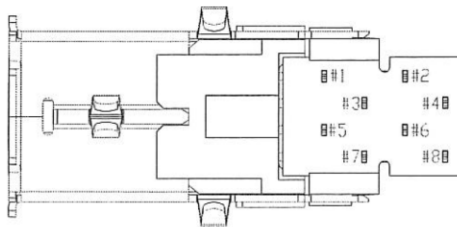
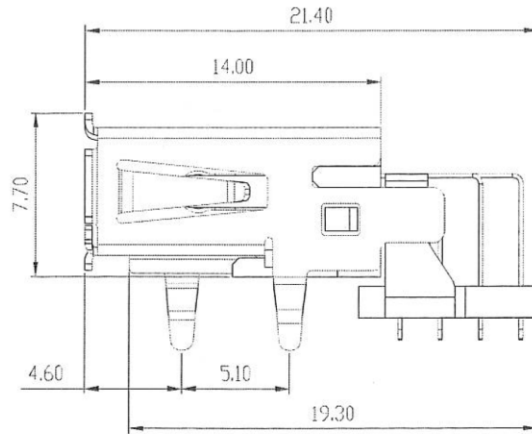
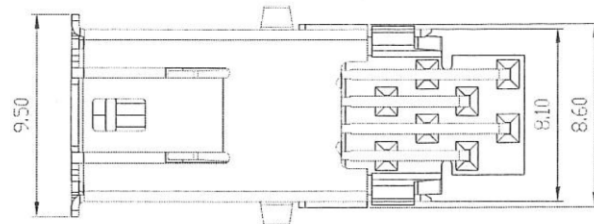

MATERIAL AND FINISH  
 CONTACT  
 COPPER ALLOY  
 UNDER ALL SURFACE NICKEL 50u" MIN  
 TOP CONTACT AREA: GOLD 20u" MIN  
 SOLDER AREA: TIN PLATE  
 HOUSING  
 THERMO PLASTIC(UL94V-0)  
 SHELL  
 COPPER ALLOY  
 UNDER ALL SURFACE NICKEL  
 TOP ALL SURFACE TIN

ITEM	DRAWING NO.	PART NAME	MATERIAL	P.N	Q'TY
③		SMS-811端子	C5191R-H,T=0.20,半金雾锡5u"		8PIN
②		SMS-813锡壳	C5191R-H,T=0.35,雾锡100u"		1PCS
①		SMS-811塑胶主体	PBT+30%G.F.,黑色,UL94V-0		1PCS

RoHS Compliant

TOLERANCES ARE

**MORETHANALL**  
 PCB CONNECTORS  
 Cable ASSEMBLIES

煜倫股份有限公司

www.morethanall.com

DRAWING BY CY

CHECKED BY GENIUS

UNIT / mm

SCALE 1 : 1

DATE

SIZE A4

X, ±  
 .X ± 0.30  
 .XX ±  
 .XXX ±  
 ANG ± 2°

PJECTION

照片框

ORDER INFORMATION

1394H-SR-08x-LF

SERIES  
 LEADFREE  
 A TYPE  
 B TYPE  
 8 PIN B TYPE  
 DIP 90°  
 FEMALE

DESCRIPTION: