

**Detail K**  
(Scale 5 : 1)

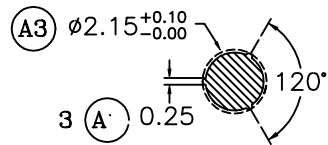

**Detail J**  
(Scale 5 : 1)

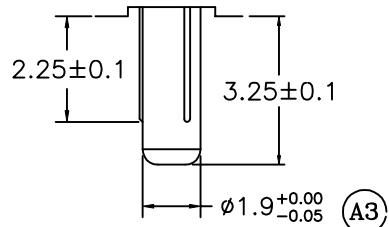
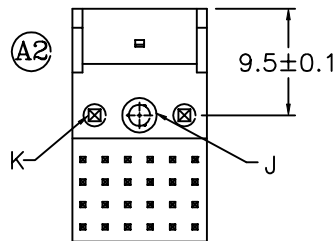
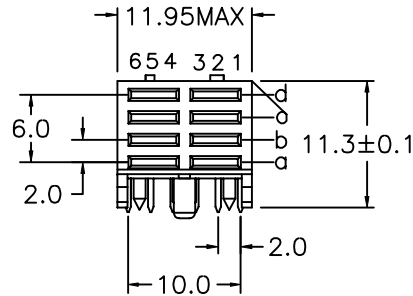
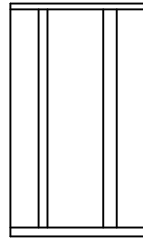

X Length	1	2
	2.90	3.53

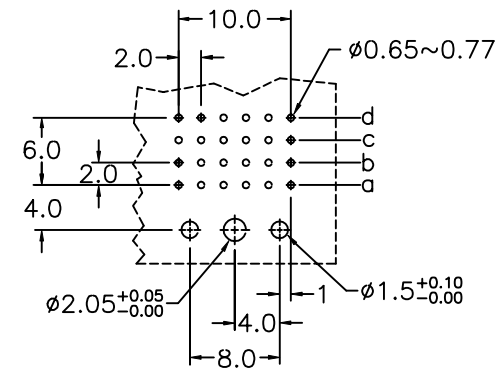
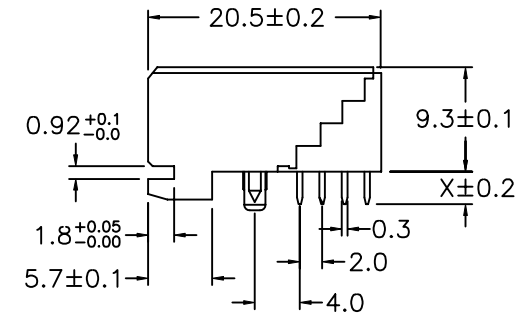

**P.C. Board Layout**

**RoHS Compliant**

TOLERANCES ARE

**MORETHANALL**  
PCB CONNECTORS  
Cable ASSEMBLIES

DRAWING BY CY  
CHECKED BY GENIUS  
UNIT / mm SCALE 1 : 1  
DATE

X, ±  
.X ±  
.XX ±  
.XXX ±  
ANG ±

**煜倫股份有限公司**

www.morethanall.com

SIZE A4 PPROJECTION

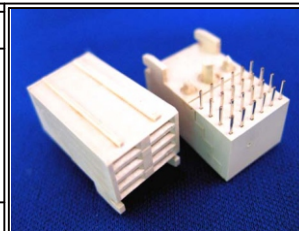

**ORDER INFORMATION**

**FUP-SRxx-4X02-LF**  
SERIES | | LEADFREE  
8 WAY  
FEMALE | 02:2.90mm  
03:3.53mm  
DIP 90°

DESCRIPTION: H.D. Female 2.0mm Dip Power Type