

NOTES :
 1. MATERIAL :
 INSULATOR : HIGH TEMPERATURE THERMOPLASTIC , UL94V-0.
 COLOR : BLACK
 CONTACT : PHOSPHOR BRONZE.

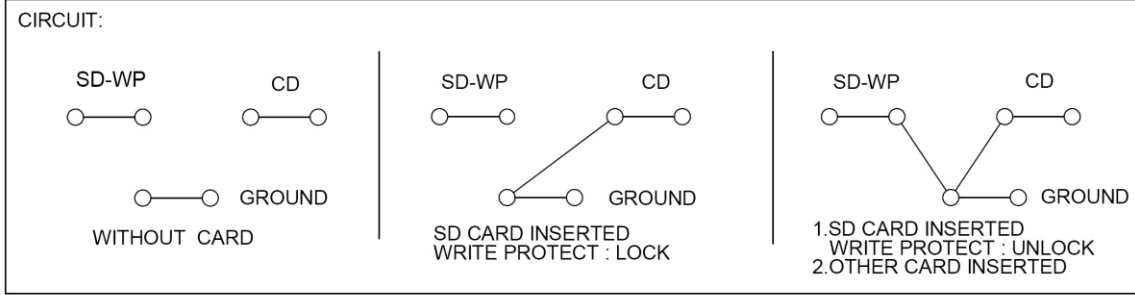
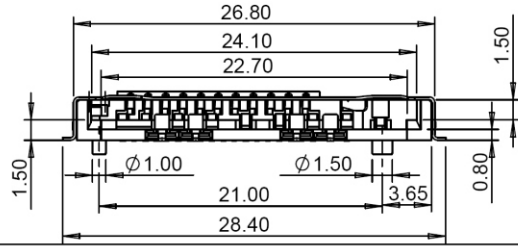
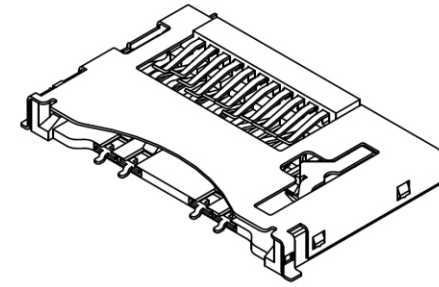

MHC-W21-601-LF
 LEADFREE
 RoHS Compliant

MORETHANALL
 CONNECTORS
 ASSEMBLIES

PART NO. MHC-W21-601

DWG NO. MHC-W21-601

CHECKED BY CY

TOLERANCES ARE

DESCRIPTION:

FILE NO.

DRAWING BY

.X ± 0.2
 .XX ±
 .XXX ±
 AWG

AREA

REVISIONS

HK

DATE

焯倫股份有限公司

UNIT / mm

SCALE 1:1

PROJECTION

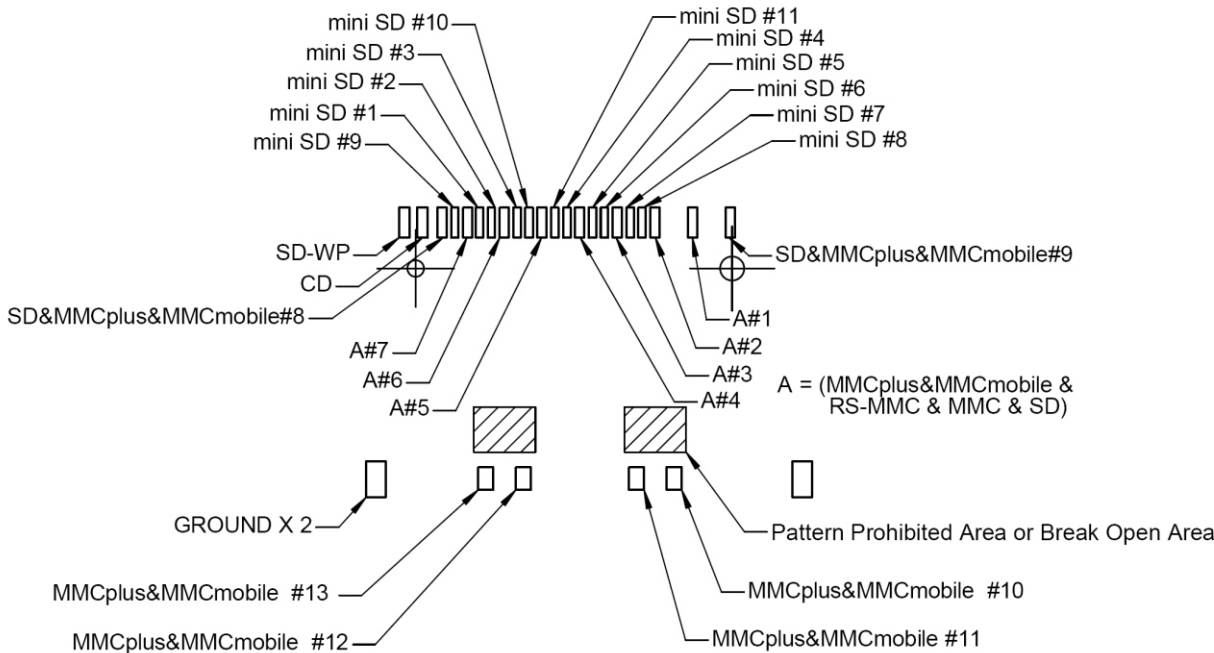

PCB LAYOUT

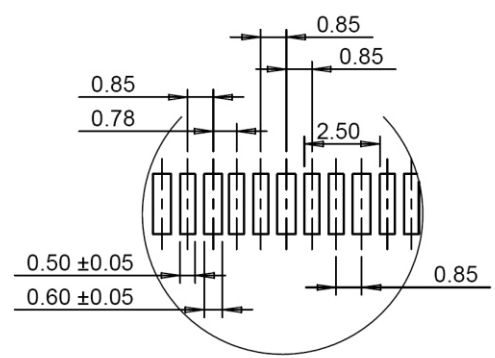

M (4 : 1)

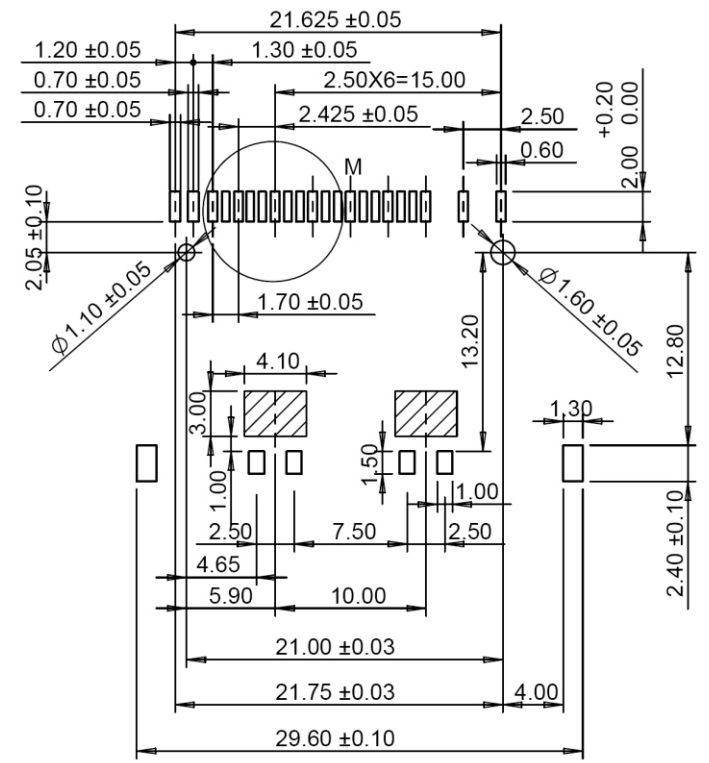

PCB LAYOUT

MORETHANALL
CONNECTORS
ASSEMBLIES

煜倫股份有限公司

PART NO. MHC-W21-601		CHECKED BY CY		TOLERANCES ARE .X ± 0.2 .XX ± .XXX ± AWG	DESCRIPTION:			
DWG NO. MHC-W21-601		DRAWING BY						
FILE NO.		PROJECTION		AREA	REVISIONS	HK	DATE	
UNIT / mm	SCALE 1:1							

PIN ASSIGNMENT:

PIN NO.	MEMORY CARD PIN NO.
MMCplus&MMCmobile&MMC&RS-MMC&SD#1	(RSV/DAT3)
MMCplus&MMCmobile&MMC&RS-MMC&SD#2	(CMD)
MMCplus&MMCmobile&MMC&RS-MMC&SD#3	(GND)
MMCplus&MMCmobile&MMC&RS-MMC&SD#4	(VCC)
MMCplus&MMCmobile&MMC&RS-MMC&SD#5	(CLK)
MMCplus&MMCmobile&MMC&RS-MMC&SD#6	(GND)
MMCplus&MMCmobile&MMC&RS-MMC&SD#7	(DAT0)
MMCplus&MMCmobile&SD#8	(DAT1)
MMCplus&MMCmobile&SD#9	(DAT2)
MMCplus&MMCmobile#10	(DAT4)
MMCplus&MMCmobile#11	(DAT5)
MMCplus&MMCmobile#12	(DAT6)
MMCplus&MMCmobile#13	(DAT7)
miniSD#1	(CD/DAT3)
miniSD#2	(CMD)
miniSD#3	(GND)
miniSD#4	(VCC)
miniSD#5	(CLK)
miniSD#6	(GND)
miniSD#7	(DAT0)
miniSD#8	(DAT1)
miniSD#9	(DAT2)
miniSD#10	(NC)
miniSD#11	(NC)



PART NO. MHC-W21-601

DWG NO. MHC-W21-601

FILE NO.

UNIT / mm

SCALE 1:1

CHECKED BY CY

DRAWING BY

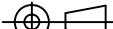
PROJECTION 

TOLERANCES ARE

.X ± 0.2
.XX ±
.XXX ±
AWG

DESCRIPTION:

6IN1(SD&miniSD&MMC&RS-MMC&MMCplus &MMCmobile) CARD CONNECTOR

AREA

REVISIONS

HK

DATE

煜倫股份有限公司