

PERFORMANCE CHARACTERISTICS

Operating Voltage: 50V AC Max.
 Current Rating: 0.5 Amp Max.
 Contact Resistance: 40 mΩ Max.
 Insulation Resistance: 50 MΩ Min.
 Dielectric Withstanding Voltage: 250V AC/minute
 Accommodated FFC/FPC Thickness: 0.30±0.03 mm
 Operating Temperature: -20°C TO +85°C

MATERIAL

Housing: High Temperature Thermoplastic;UL 94V-0
 (Color : Ivory)
 Actuator: High Temperature Thermoplastic;UL 94V-0
 (Color : Black)
 Terminal: Copper Alloy
 ME: Copper Alloy
 Plating: See ordering information

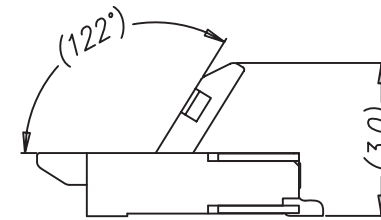

(WHEN ACTUATOR IS OPEN)

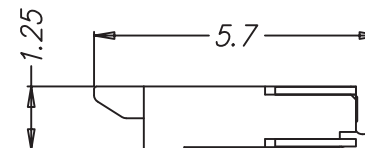

RoHS Compliant

TOLERANCES ARE

MORETHANALL
 PCB CONNECTORS
 Cable ASSEMBLIES

DRAWING BY CY
 CHECKED BY GENIUS
 UNIT / mm SCALE 1 : 1
 DATE

X. ±
 .X ±
 .XX ±
 .XXX ±
 ANG ±

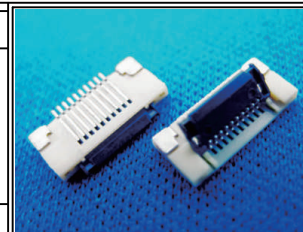

ORDER INFORMATION

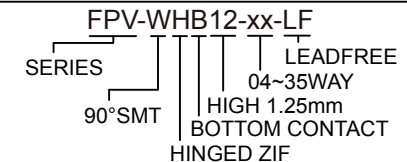

煜倫股份有限公司

www.morethanall.com

SIZE A4 PPOJECTION

DESCRIPTION:

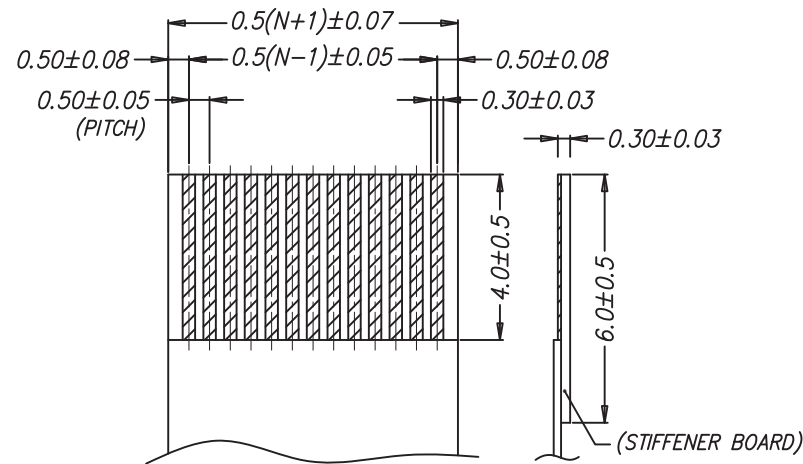
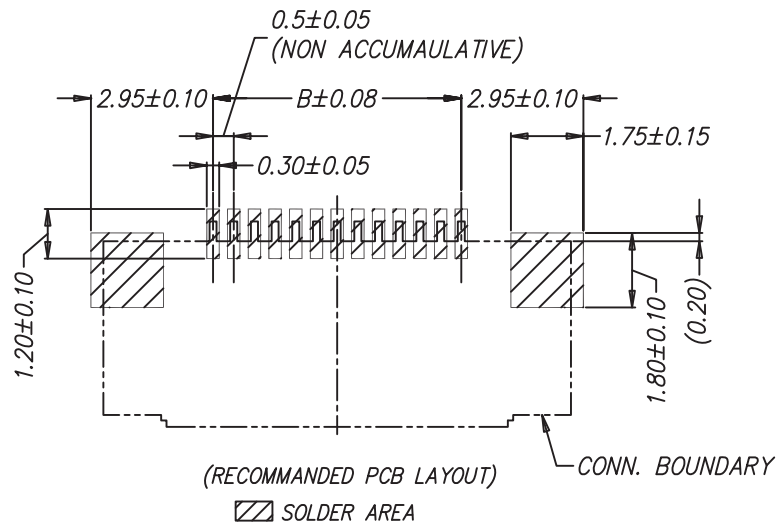

TABLE OF DIM.

POS.	A	B	C
4	6.95	1.50	2.55
5	7.45	2.00	3.05
6	7.95	2.50	3.55
7	8.45	3.00	4.05
8	8.95	3.50	4.55
9	9.45	4.00	5.05
10	9.95	4.50	5.55
11	10.45	5.00	6.05
12	10.95	5.50	6.55
13	11.45	6.00	7.05
14	11.95	6.50	7.55
15	12.45	7.00	8.05
16	12.95	7.50	8.55
17	13.45	8.00	9.05
18	13.95	8.50	9.55
19	14.45	9.00	10.05
20	14.95	9.50	10.55
21	15.45	10.00	11.05
22	15.95	10.50	11.55
23	16.45	11.00	12.05
24	16.95	11.50	12.55
25	17.45	12.00	13.05
26	17.95	12.50	13.55
27	18.45	13.00	14.05
28	18.95	13.50	14.55
29	19.45	14.00	15.05
30	19.95	14.50	15.55
31	20.45	15.00	16.05
32	20.95	15.50	16.55
33	21.45	16.00	17.05
34	21.95	16.50	17.55
35	22.45	17.00	18.05

RoHS Compliant

TOLERANCES ARE

MORETHANALL
PCB CONNECTORS
Cable ASSEMBLIES

DRAWING BY CY

X.±

CHECKED BY GENIUS

.X±

UNIT / mm

SCALE 1 : 1

.XX±

DATE

.XXX±

ANG±

SIZE A4

PPOJECTION

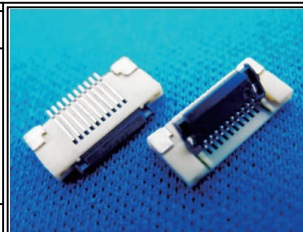

ORDER INFORMATION

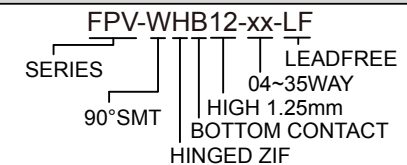

DESCRIPTION:

煜倫股份有限公司

www.morethanall.com