

- NOTES :
- MATERIAL :
INSULATOR : HIGH TEMPERATURE THERMOPLASTIC , UL94V-0.
COLOR : BLACK
CONTACT : PHOSPHOR BRONZE.
 - APPLICATION : SD&HS SD&SDHC&MMC&MMCplus&xD&MS&MS PRO&MagicGate MS&MS-ROM&MS I/O Expansion
(It can protect the damage of MSDuo)

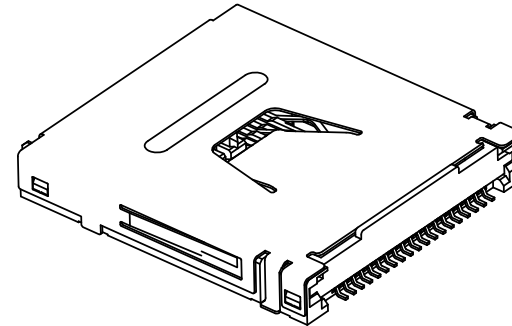

RoHS Compliant

TOLERANCES ARE

MORETHANALL
PCB CONNECTORS
Cable ASSEMBLIES

DRAWING BY CY

X, ±

CHECKED BY GENIUS

.X ±

UNIT / mm

SCALE 1 : 1

.XX ±

DATE

.XXX ±

ANG ±

SIZE A4

PJECTION

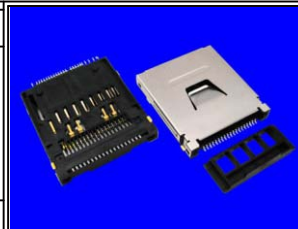

ORDER INFORMATION

MHC-W17-401-LF
SERIES | LEADFREE
4 IN 1
POST TO POST 17.0mm
90°SMT

煜倫股份有限公司

www.morethanall.com

DESCRIPTION: Multi-Card CONNECTOR

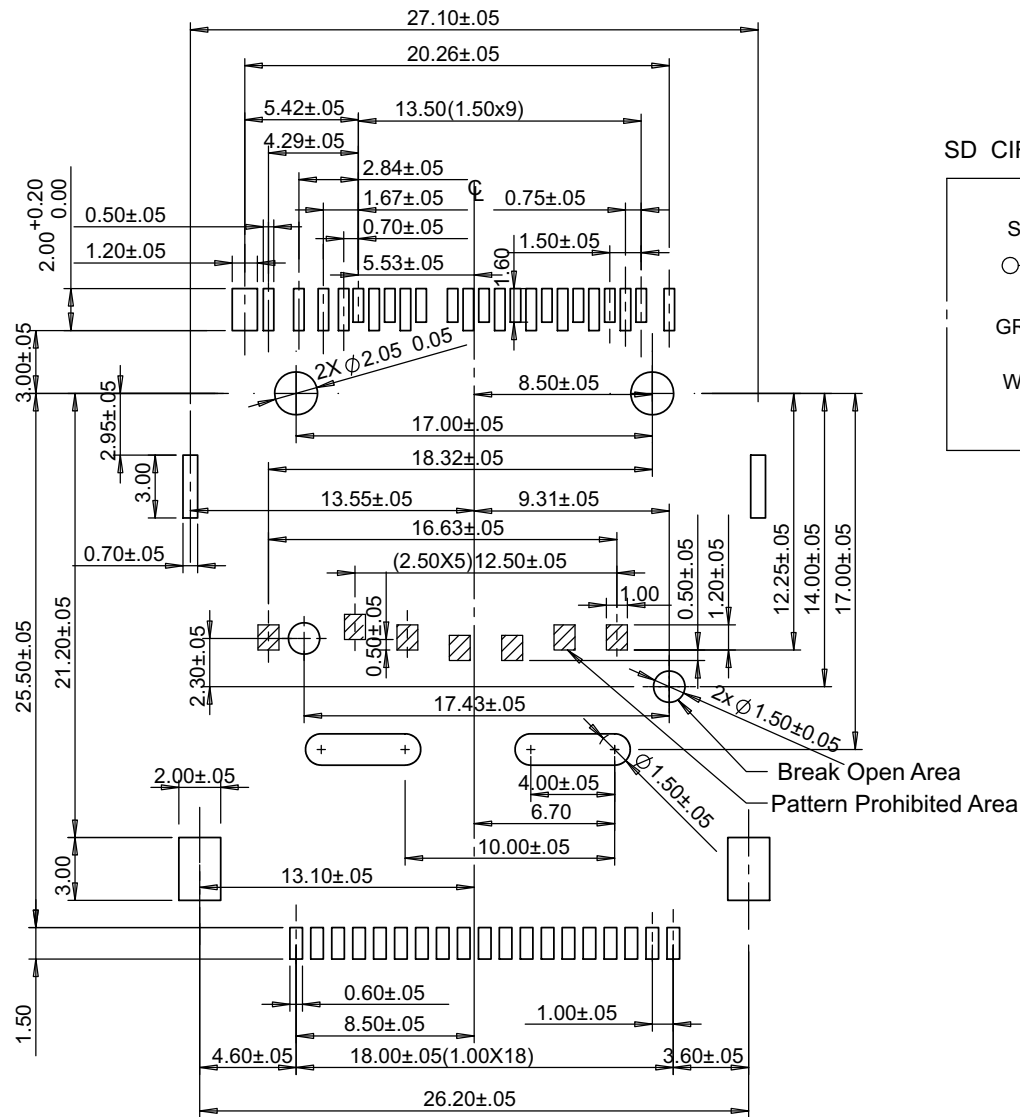

PCB LAYOUT

SD CIRCUIT :

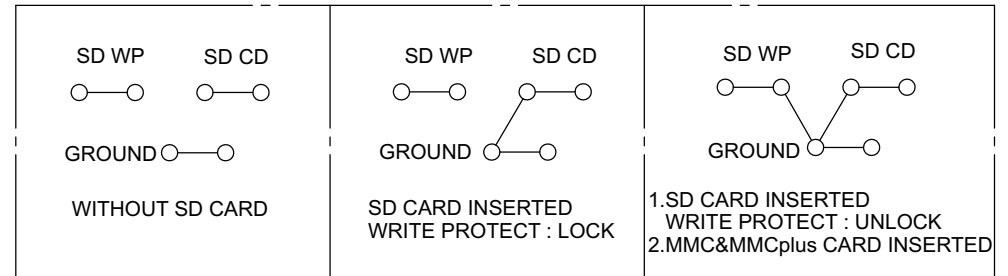

xD CIRCUIT :

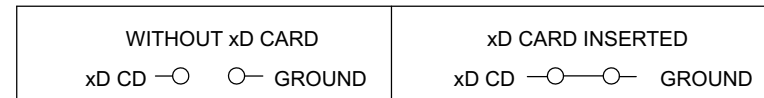

煜倫股份有限公司

www.morethanall.com

RoHS Compliant

DRAWING BY CY
CHECKED BY GENIUS
UNIT / mm SCALE 1 : 1
DATE
SIZE A4 PPROJECTION

TOLERANCES ARE
X, ±
.X, ±
.XX, ±
.XXX, ±
ANG, ±

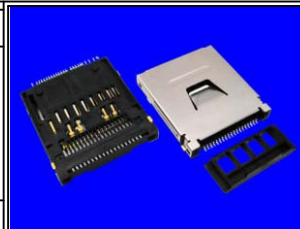

ORDER INFORMATION

MHC-W17-401-LF
SERIES | LEADFREE
4 IN 1
POST TO POST 17.0mm
90°SMT

DESCRIPTION: Multi-Card CONNECTOR

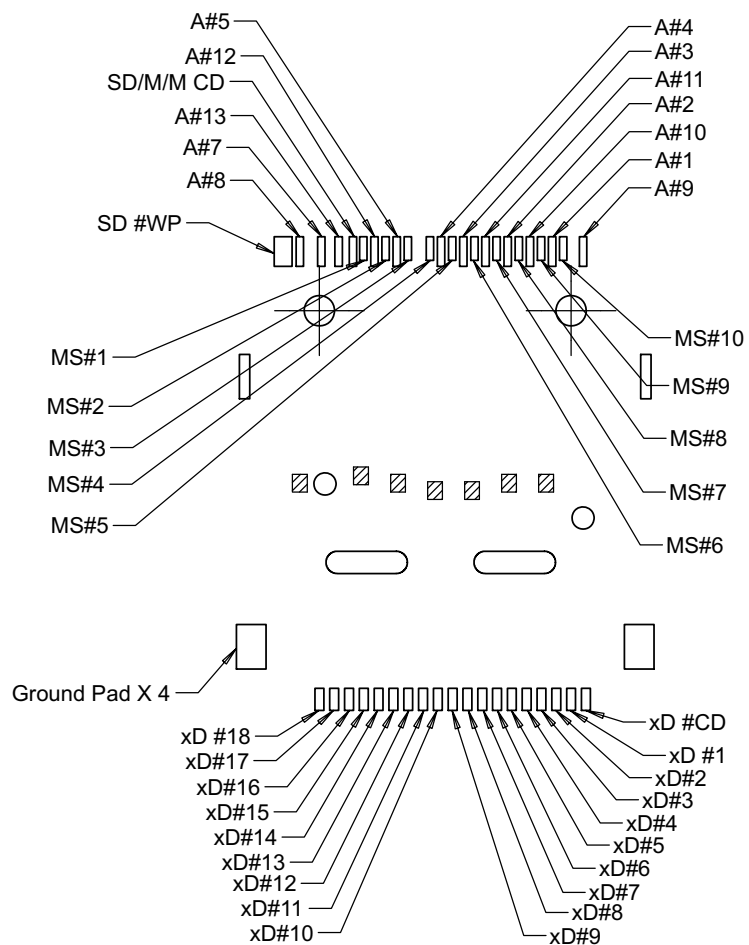

PCB LAYOUT

PIN ASSIGNMENT:

PIN NO.	MEMORY CARD PIN NO.	PIN NO.	MEMORY CARD PIN NO.	PIN NO.	MEMORY CARD PIN NO.
A#1	SD/M/M-1 (DAT3)	MS#1	VSS	xD#18	(VCC)
A#2	SD/M/M-2 (CMD)	MS#2	BS	xD#17	(D7)
A#3	SD/M/M-3 (GND)	MS#3	DAT1	xD#16	(D6)
A#4	SD/M/M-4 (VCC)	MS#4	SDIO/DATA0	xD#15	(D5)
A#5	SD/M/M-5 (CLK)	MS#5	DATA2	xD#14	(D4)
A#7	SD/M/M-7 (DAT0)	MS#6	INS	xD#13	(D3)
A#8	SD/MMCplus-8 (DAT1)	MS#7	DATA3	xD#12	(D2)
A#9	SD/MMCplus-9 (DAT2)	MS#8	SCLK	xD#11	(D1)
A#10	MMCplus-10 (DAT4)	MS#9	VCC	xD#10	(D0)
A#11	MMCplus-11 (DAT5)	MS#10	VSS	xD#9	(GND)
A#12	MMCplus-12 (DAT6)			xD#8	(-WP)
A#13	MMCplus-13 (DAT7)			xD#7	(-WE)
				xD#6	(ALE)
				xD#5	(CLE)
				xD#4	(-CE)
				xD#3	(-RE)
				xD#2	(R/-B)
				xD#1	(GND)

(SD/M/M : SD&HS SD&SDHC&MMC&MMCplus CARD)

(MS : MS&MS PRO&MagicGate MS&MS-ROM&MS I/O Expansion CARD)

RoHS Compliant

TOLERANCES ARE

MORETHANALL
PCB CONNECTORS
Cable ASSEMBLIES

DRAWING BY CY

CHECKED BY GENIUS

UNIT / mm

SCALE 1 : 1

DATE

SIZE A4

PPOJECTION

X, ±
.X ±
.XX ±
.XXX ± 0.10
ANG ±



ORDER INFORMATION

MHC-W17-401-LF
SERIES | LEADFREE
4 IN 1
POST TO POST 17.0mm
90°SMT

煜倫股份有限公司

www.morethanall.com

DESCRIPTION: Multi-Card CONNECTOR