

A-A SECTION

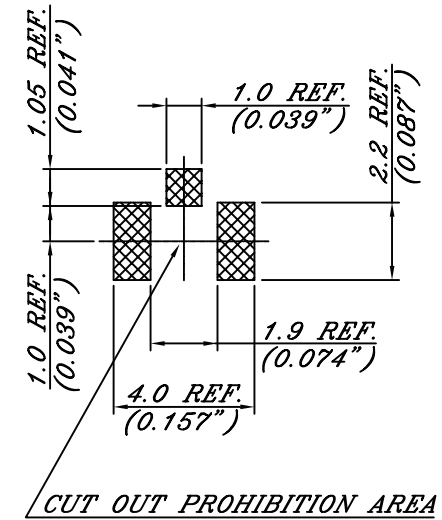

RECOMMENDED P.C.B PATTERN

DIMENSION:

Unless otherwise specified all Dimensions in millimeters & inches. Values in brackets are inches equivalents.

RoHS Compliant

MORETHANALL
PCB CONNECTORS
Cable ASSEMBLIES

煜倫股份有限公司

www.morethanall.com

DRAWING BY CY

CHECKED BY GENIUS

UNIT/mm SCALE 1:1

DATE

SIZE A4

TOLERANCES ARE

X. ±
.X ±
.XX ±
.XXX ±
ANG ±

PJECTION

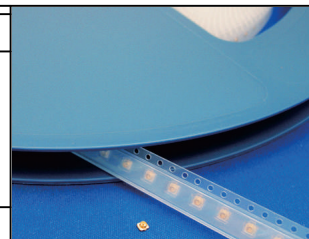

ORDER INFORMATION

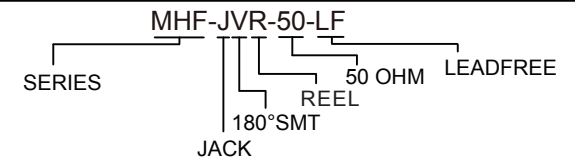

DESCRIPTION: COAX. MICROWAVE CONNECTOR

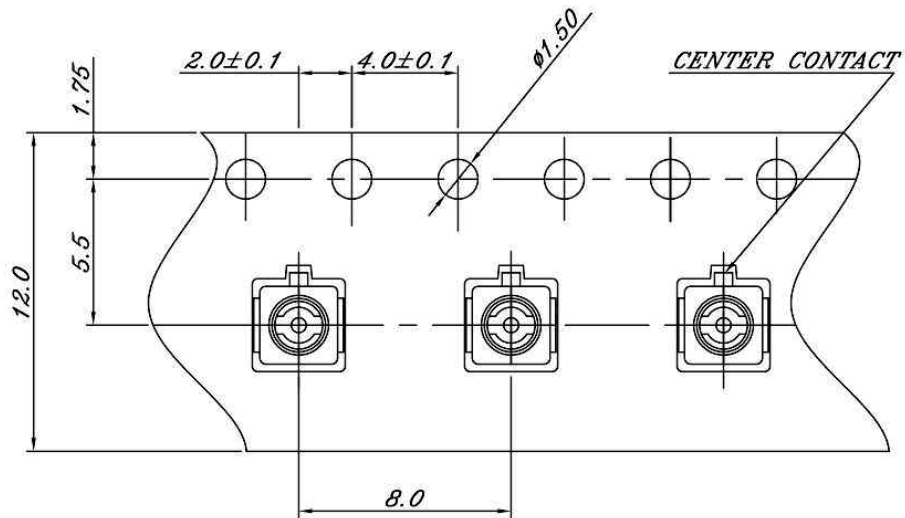

DIMENSIONS OF TAPING

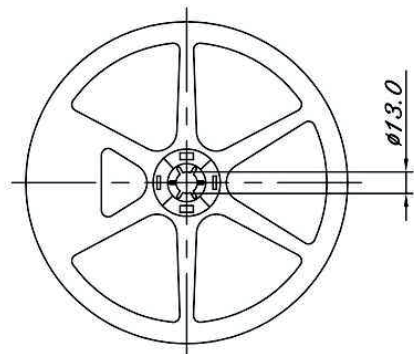
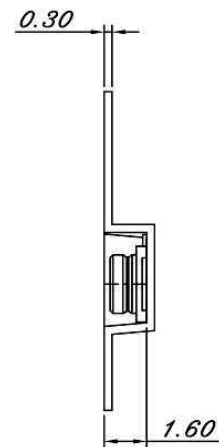

DIMENSIONS OF REEL (2500 PIECES/REEL)

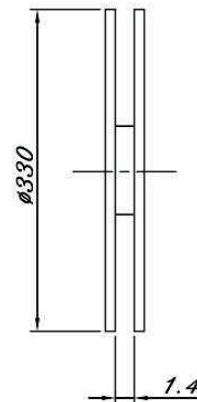

RoHS Compliant

TOLERANCES ARE

MORETHANALL
PCB CONNECTORS
Cable ASSEMBLIES

煜倫股份有限公司

www.morethanall.com

DRAWING BY CY

CHECKED BY GENIUS

UNIT/mm

SCALE 1:1

DATE

SIZE A4

P PROJECTION

X. ±
.X ±
.XX ±
.XXX ±
ANG ±

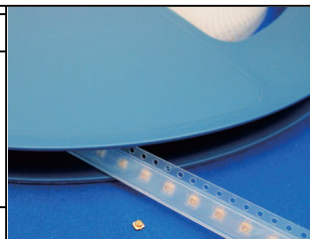

ORDER INFORMATION

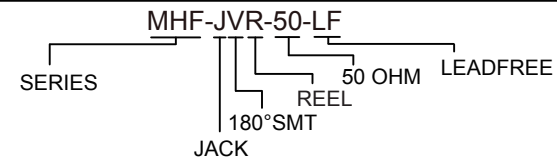

DESCRIPTION:

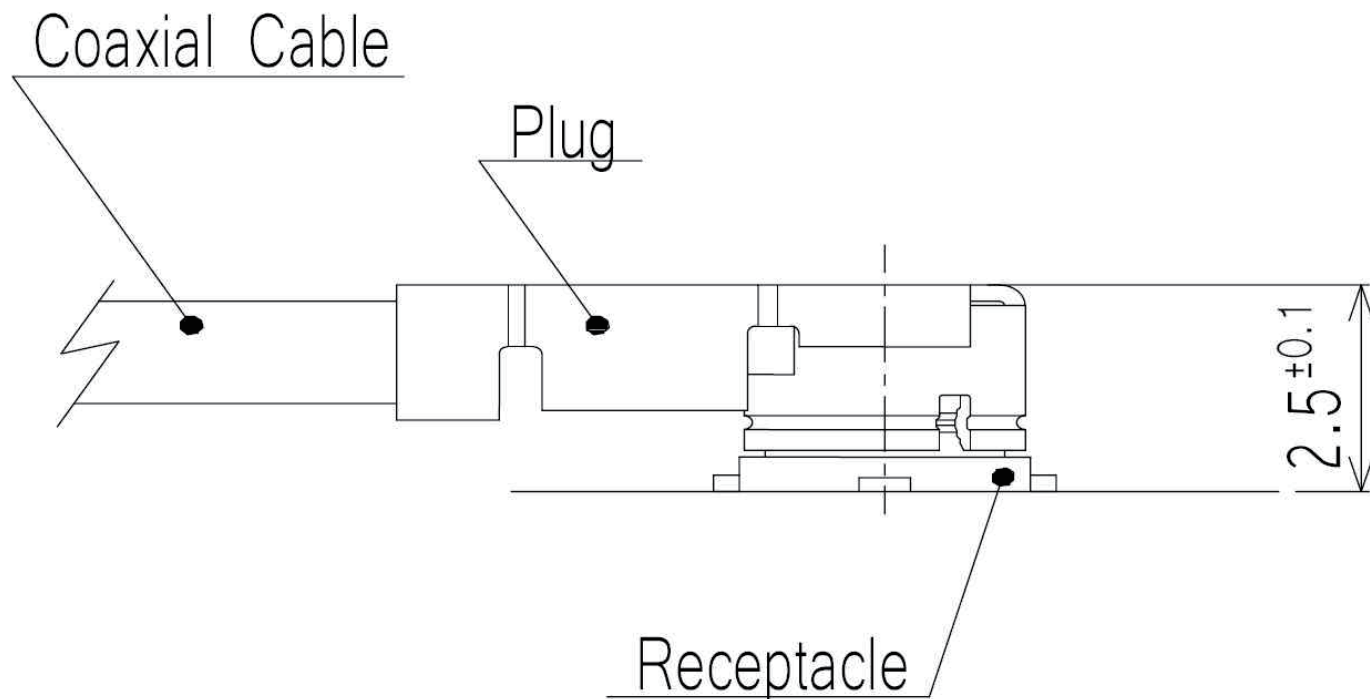

MATING

RoHS Compliant

TOLERANCES ARE

MORETHANALL
PCB CONNECTORS
Cable ASSEMBLIES

DRAWING BY CY

X. ±

CHECKED BY GENIUS

.X ±

UNIT/ mm

SCALE 1:1

.XX ±

DATE

.XXX ±

ANG ±

煜倫股份有限公司

www.morethanall.com

SIZE A4

P PROJECTION

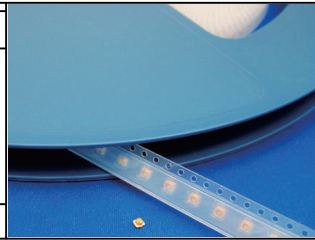

ORDER INFORMATION

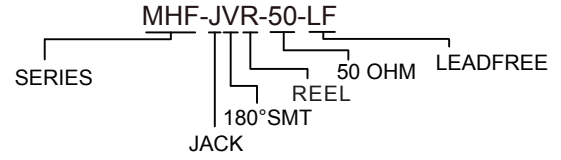

DESCRIPTION: