

NOTES:

1. MATERIAL:  
HOUSING: PA66 FR-370 , 25% MAX REGRIND , UL94 V-0 , WHITE  
CONTACT: BRASS C2700 ,  $\phi 0.60$
2. FINISH: 2um [80u"] MIN. BRIGHT-TIN OVER  
1.27um [50u"]MIN. NICKEL UNDERPLATED OVER ALL
3. BURR: 0.05MAX
4. CONTACT SOLDER TAIL KINK DIRECTION (BOARLOCK)

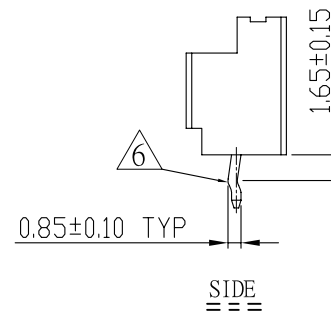
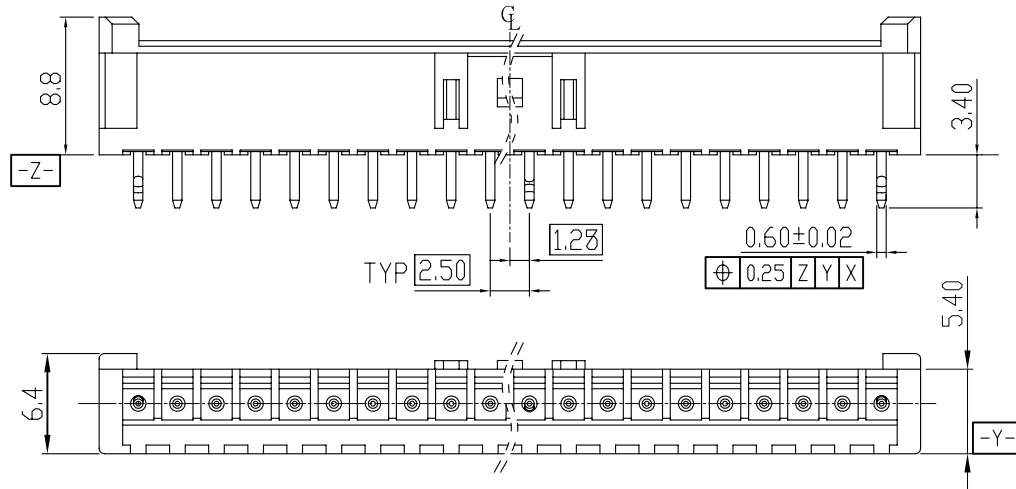
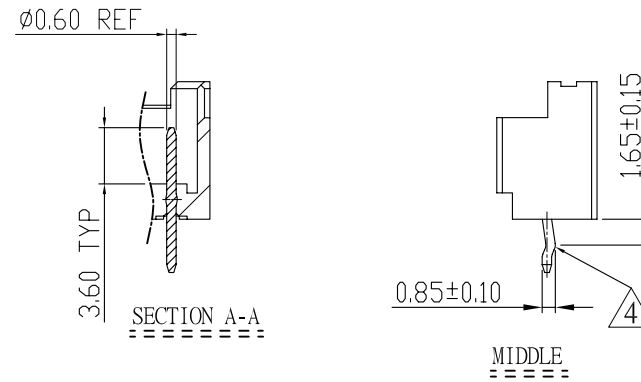
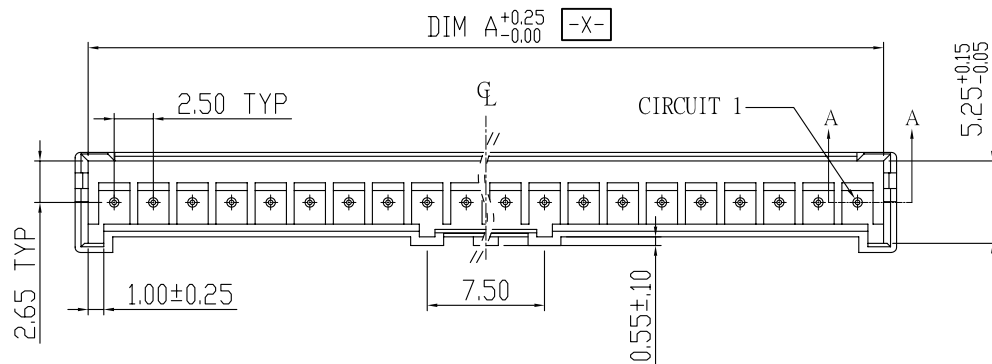

RoHS Compliant

TOLERANCES ARE

**MORETHANALL**  
PCB CONNECTORS  
Cable ASSEMBLIES

DRAWING BY CY

CHECKED BY GENIUS

UNIT/mm SCALE 1:1

DATE

SIZE A4

X. ±  
.X ±  
.XX ±  
.XXX ±  
ANG ±

PJECTION

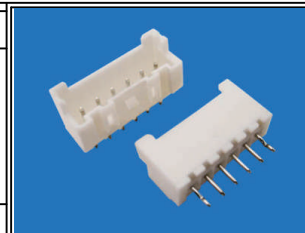

ORDER INFORMATION

XA-DX-xx-LF  
SERIES | LEADFREE  
02~20WAY  
NON POST  
DIP 180°

煜倫股份有限公司

www.morethanall.com

DESCRIPTION:

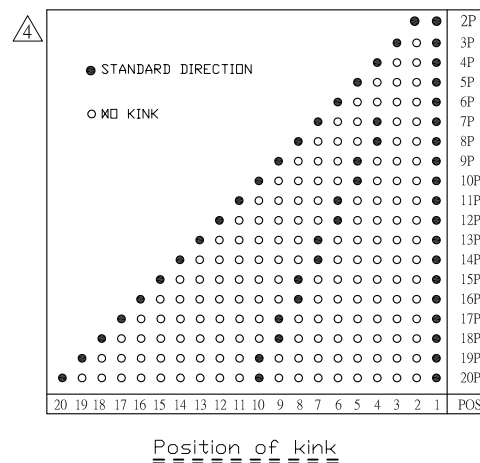
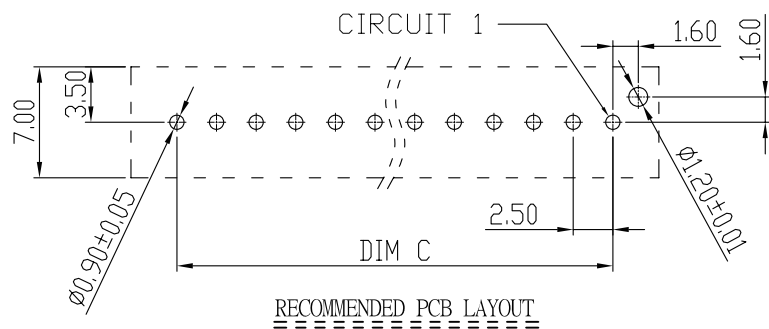
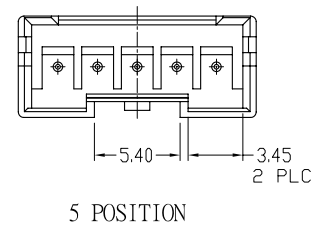
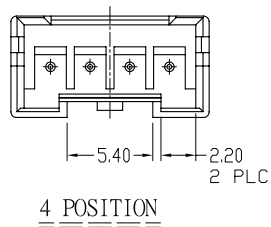
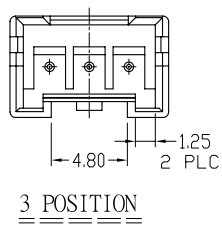
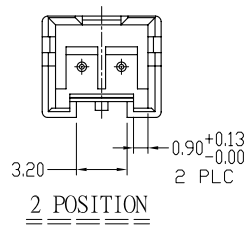

16	50.83	20	XA-DX-20
15	45.83	18	XA-DX-18
14	38.33	15	XA-DX-15
13	35.83	14	XA-DX-14
12	33.33	13	XA-DX-13
11	30.83	12	XA-DX-12
10	28.33	11	XA-DX-11
9	25.83	10	XA-DX-10
8	23.33	9	XA-DX-09
7	20.83	8	XA-DX-08
6	18.33	7	XA-DX-07
5	15.83	6	XA-DX-06
4	13.33	5	XA-DX-05
3	10.83	4	XA-DX-04
2	8.33	3	XA-DX-03
1	5.83	2	XA-DX-02
NOTE	DIM A	POSN	PART NO

**RoHS Compliant**

TOLERANCES ARE

**MORETHANALL**  
PCB CONNECTORS  
Cable ASSEMBLIES

DRAWING BY CY

CHECKED BY GENIUS

UNIT/ mm SCALE 1:1

DATE

SIZE A4

X. ±  
.X ±  
.XX ±  
.XXX ±  
ANG ±

PJECTION

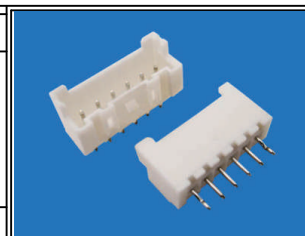

**ORDER INFORMATION**

XA-DX-xx-LF  
SERIES | LEADFREE  
02~20WAY  
NON POST  
DIP 180°

煜倫股份有限公司

www.morethanall.com

DESCRIPTION: