

CKT	DIM.A	DIM.B	DIM.C	DIM.D
3	2.50	4.50	9.00	9.60
4	3.75	5.75	10.25	10.85
5	5.00	7.00	11.50	12.10
6	6.25	8.25	12.75	13.35
7	7.50	9.5	14.00	14.60
8	8.75	10.75	15.25	15.85
9	10.00	12.00	16.50	17.10
10	11.25	13.25	17.75	18.35
11	12.50	14.50	19.00	19.60
12	13.75	15.75	20.25	20.85
13	15.00	17.00	21.50	22.10
14	16.25	18.25	22.75	23.35
15	17.50	19.50	24.00	24.60
16	18.75	20.75	25.25	25.85
17	20.00	22.00	26.50	27.10
18	21.25	23.25	27.75	28.35
19	22.50	24.50	29.00	29.60
20	23.75	25.75	30.25	30.85
21	25.00	27.00	31.50	32.10
22	26.25	28.25	32.75	33.35
23	27.50	29.50	34.00	34.60
24	28.75	30.75	35.25	35.85
25	30.00	32.00	36.50	37.10
26	31.25	33.25	37.75	38.35
27	32.50	34.50	39.00	39.60
28	33.75	35.75	40.25	40.85
29	35.00	37.00	41.50	42.10
30	36.25	38.25	42.75	43.35

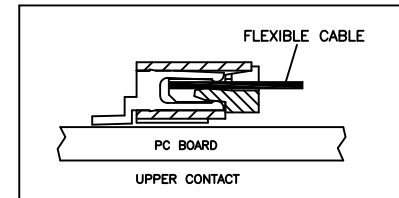
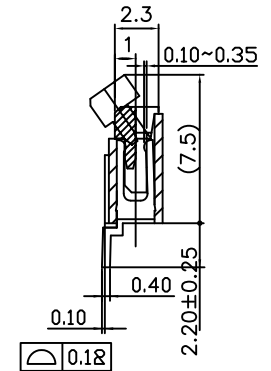
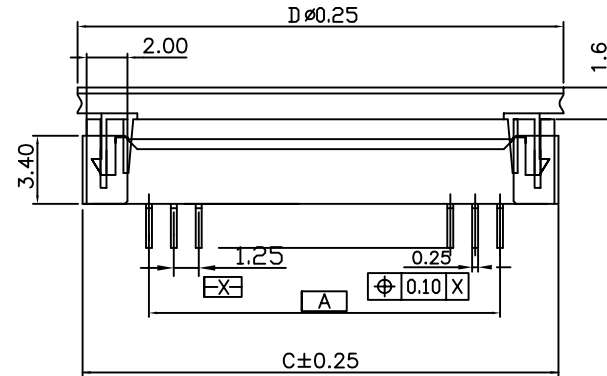
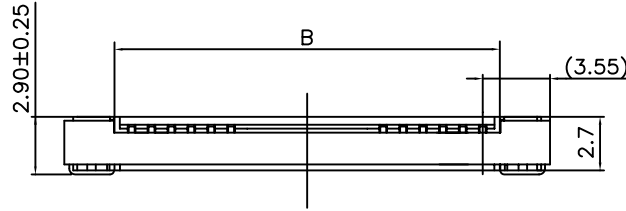
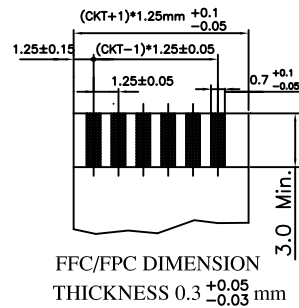
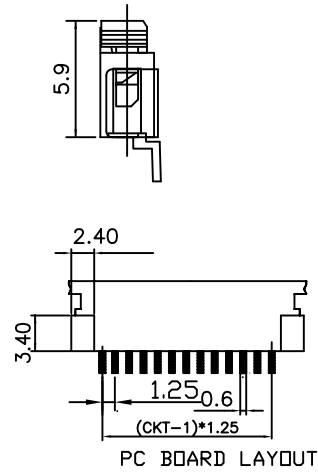

FPB-WZA-xx

NOTES:

- MATERIALS: HOUSING-LCP
TERMINAL-PHOSPHOR BRONZE, LATCH -Brass
- CAMBER: 0.05mm/cm MAX, DEFORMATION: NA,
WARP: 0.05mm/cm MAX, TWIST: NA.

RoHS Compliant

TOLERANCES ARE

MORETHANALL
PCB CONNECTORS
Cable ASSEMBLIES

DRAWING BY CY

CHECKED BY GENIUS

UNIT / mm

SCALE 1 : 1

DATE

SIZE A4

PJECTION

X, ±
.X ±
.XX ±
.XXX ±
ANG ±

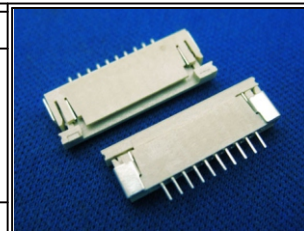

ORDER INFORMATION

FPB-WZA-xx-LF
SERIES | | LEADFREE
| | 03-30WAY
| | UPPER CONTACT
ZIF
90°SMT

煜倫股份有限公司

www.morethanall.com

DESCRIPTION: