

规格说明: Specifications:

电气特性: Electrical:

1. 额定电流: Current Rating
1.0A/contact terminal
2. 额定电压: Voltage Rating
30V DC
3. 接触阻抗: Contact Resistance
50 milliohms MAX
4. 耐电压: Dielectric Withstanding Voltage:
300 V AC AT Sea Level
5. 绝缘阻抗: Insulation Resistance:
100MEGA ohms MIN

原材料: Raw material:

1. 塑胶: Plastic cement:
Hing Temperature Thermoplastics,
LCP Black
2. 端子: Contact: Copper Alloy C2680/C5191
3. 外壳: Shell: SPCC/Copper Alloy C2680

电镀: Electroplate:

1. 端子: Contact: Plated Gold 30U" in Mating Area;
Tin On Solder Talls
2. 外壳: Shell:
Nickel Plating

RoHS Compliant

MORETHANALL
PCB CONNECTORS
Cable ASSEMBLIES

煜倫股份有限公司

www.morethanall.com

DRAWING BY CY

CHECKED BY GENIUS

UNIT/ mm SCALE 1:1

DATE

SIZE A4

TOLERANCES ARE

X. ± 0.30
X. ± 0.25
.XX ± 0.20
.XXX ± 0.10
ANG ± 5°

P PROJECTION

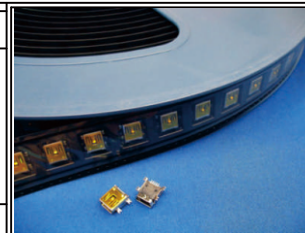

ORDER INFORMATION

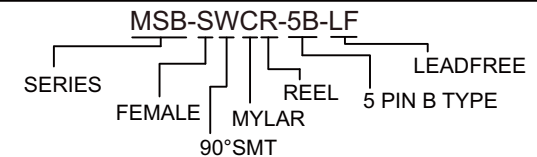

DESCRIPTION: MINI-U.S.B 5P B FEMALE S.M.T



1 胶盘

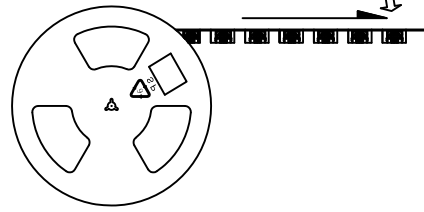
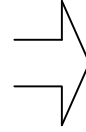

2 1000pcs/盘

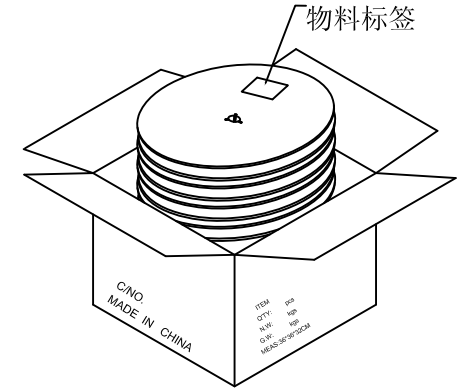
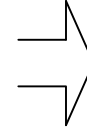

3 10盘/箱 (1000Kpcs)

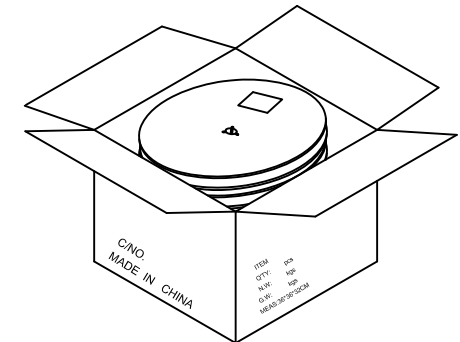
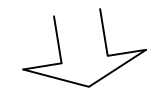

4 每箱装10盘, 若尾数箱在空间处加装填充物.

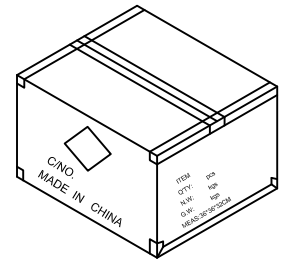
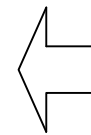

5 外箱用透明胶纸带封“工”字型.

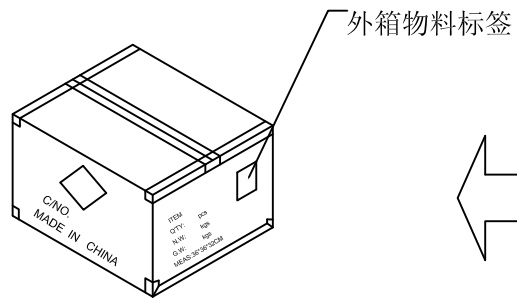
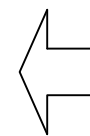

6 依图示粘贴产品或ROHS标签.

备注:

- 1. 胶盘规格: 330*28mm
- 2. 每盘装1000pcs;
- 3. 每箱装10盘(10 Kpcs);
- 4. 外箱尺寸:长*宽*高: 36*36*32cm;
- 5. 外箱用透明胶纸带封“工”字型;
- 6. 依外箱图示位置粘贴好产品或ROHS标签.

RoHS Compliant

TOLERANCES ARE

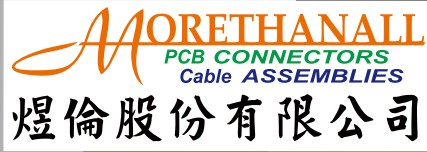

DRAWING BY CY
 CHECKED BY GENIUS
 UNIT / mm SCALE 1 : 1
 DATE

X, ±
 .X ±
 .XX ±
 .XXX ±
 ANG ±

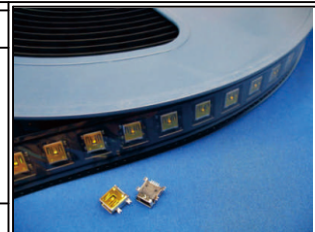

ORDER INFORMATION

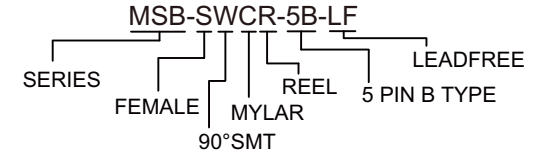

www.morethanall.com

SIZE A4 PROJECTION

DESCRIPTION: