

TYPE	CONTACT NO.	L
DETECT	36 ,67	3.5
GENERAL	OTHERS	4.25
POWER	1,17,34,35,51,68	5.0

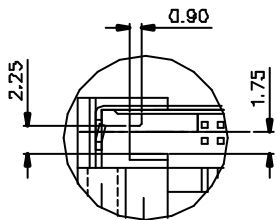

A VIEW
S=2/1
FOR 3.3 V

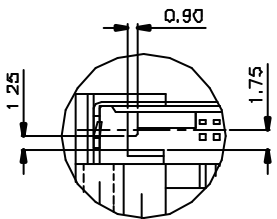

A VIEW
S=2/1
FOR 5.0 V

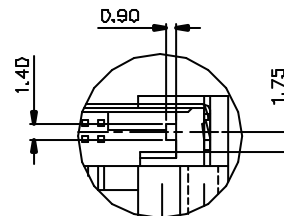
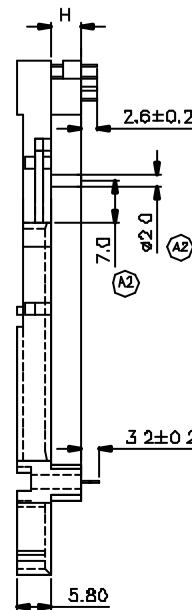
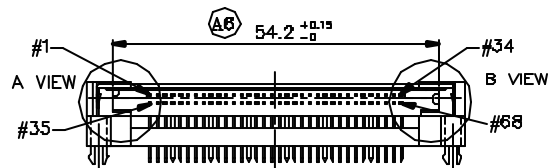
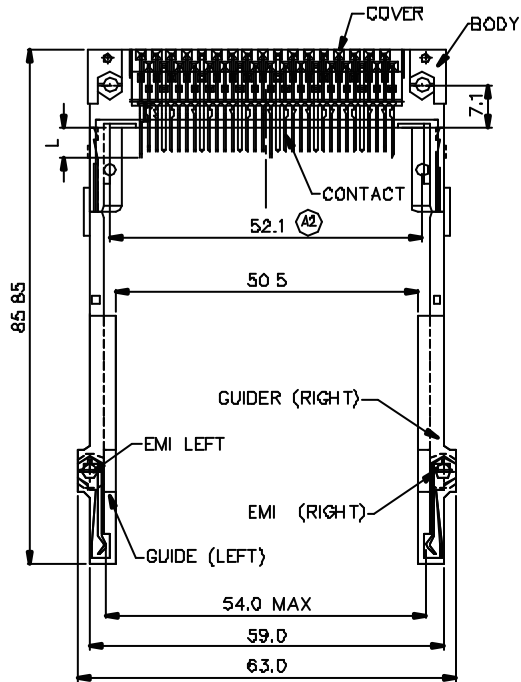

B VIEW
S=2/1

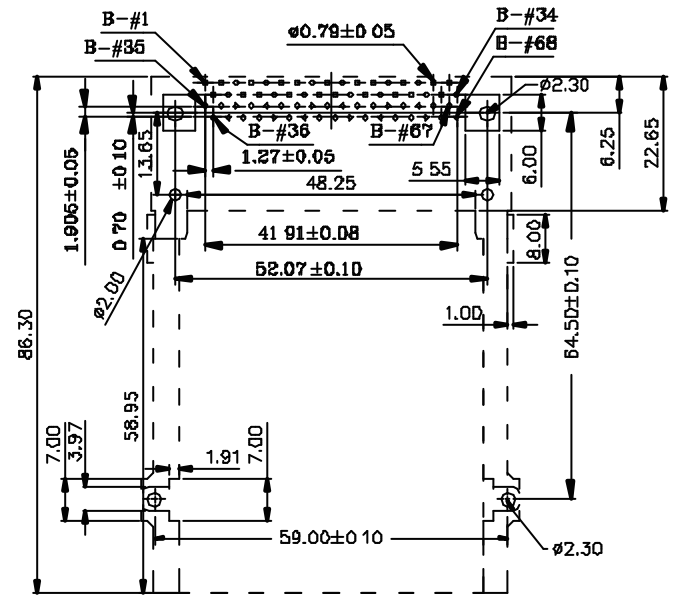

H	Dimension
00	0.00mm
20	2.00mm
28	2.80mm
40	4.00mm
50	5.00mm
80	8.00mm
22	2.20mm

RoHS Compliant

TOLERANCES ARE

MORETHANALL
PCB CONNECTORS
Cable ASSEMBLIES

煜倫股份有限公司

www.morethanall.com

DRAWING BY CY

CHECKED BY GENIUS

UNIT/ mm SCALE 1:1

DATE

SIZE A4

X, ±
.X ±
.XX ±
.XXX ±
ANG ±

P PROJECTION



ORDER INFORMATION

PCC-PRLxxVxZ-68-LF

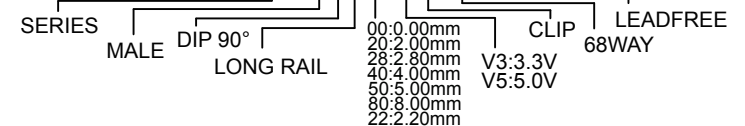

DESCRIPTION: PCMCIA CONNECTOR LONG TYPE WITH GUIDE RAIL