

\* Material : Brass

\* Applicable wire : AWG# 28-#22

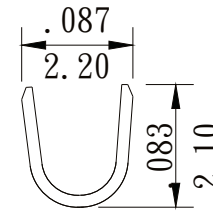

B-B

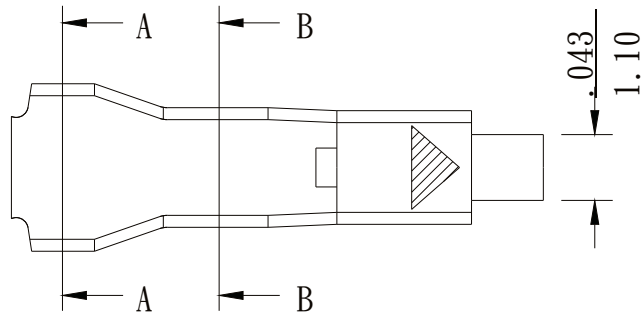
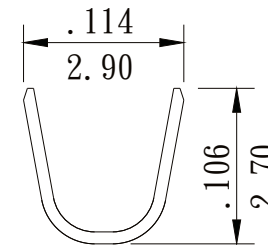
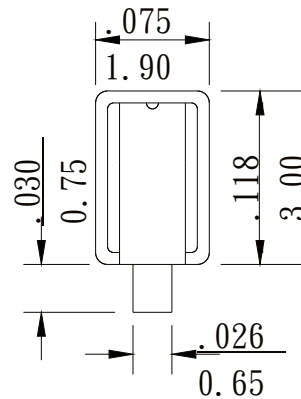
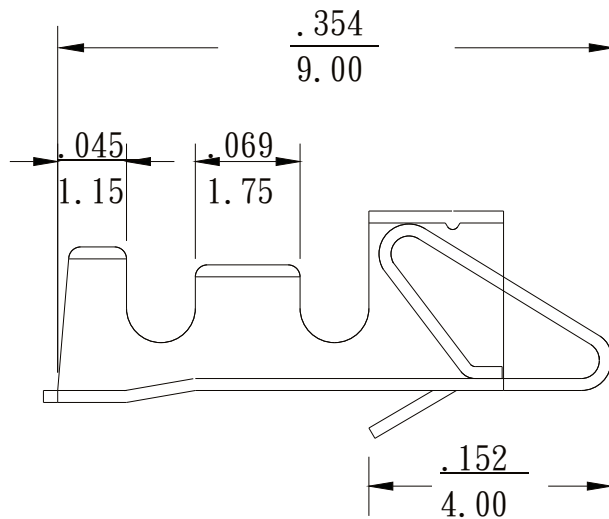

A-A

inch  
mm

RoHS Compliant

TOLERANCES ARE

**MORETHANALL**  
PCB CONNECTORS  
Cable ASSEMBLIES

煜倫股份有限公司

www.morethanall.com

DRAWING BY CY

CHECKED BY GENIUS

UNIT / mm SCALE 1:1

DATE

SIZE A4

PJECTION

X, ±  
.X ±  
.XX ±  
.XXX ±  
ANG ±

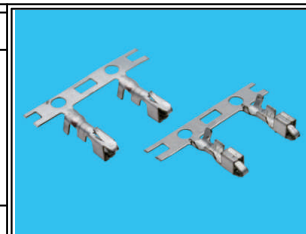

ORDER INFORMATION

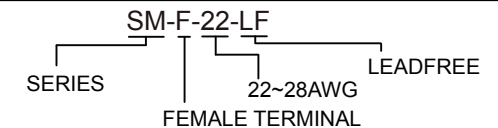

DESCRIPTION: (2.5mm) Wire-to-Wire Connectors