

SPECIFICATIONS

CURRENT RATING: 3 AMP

INSULATION RESISTANCE: 1000M OHMS MIN.

DIELECTRIC WITHSTANDING: 600V AC/DC

CONTACT RESISTANCE: 20m OHMS MAX.

OPERATING TEMPERATURE: -25°C ~ +85°C

MATERIALS

CONTACT MATERIAL: PHOSPHOR BRONZE

INSULATION MATERIAL: POLYESTER, UL 94V-0

NYLON 6T

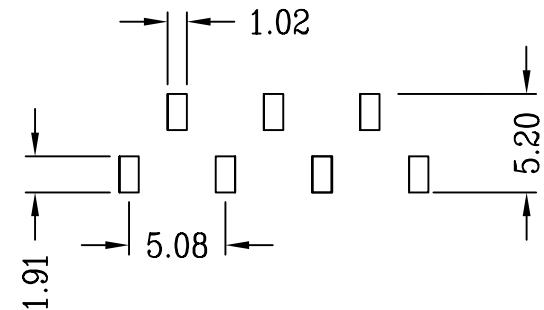
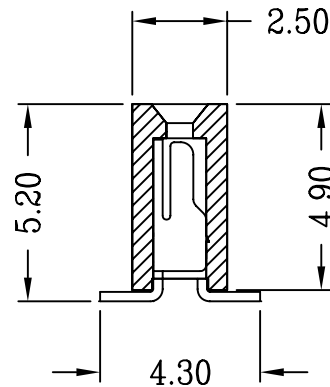
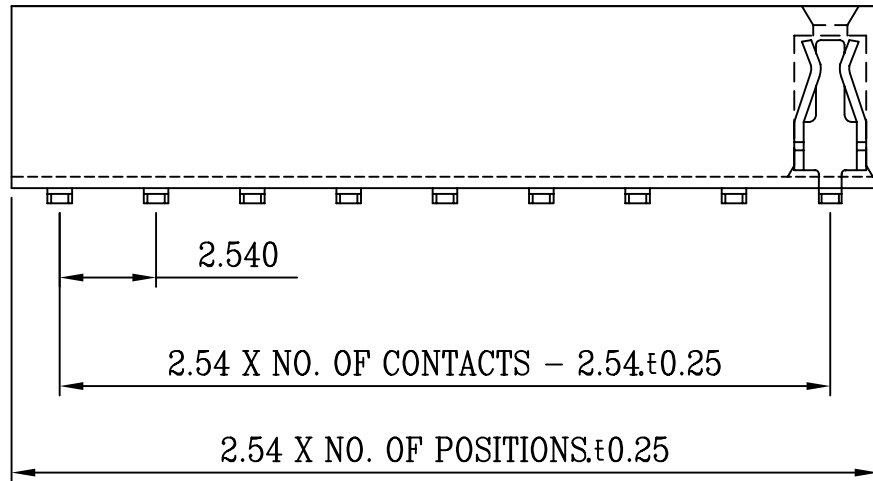
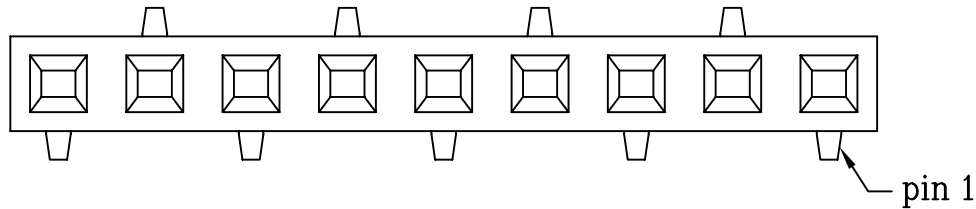

RECOMMENDED P.C.B LAYOUT

RoHS Compliant

TOLERANCES ARE

MORETHANALL
PCB CONNECTORS
Cable ASSEMBLIES

煜倫股份有限公司

www.morethanall.com

DRAWING BY CY

CHECKED BY GENIUS

UNIT / mm

SCALE 1:1

DATE

SIZE A4

P PROJECTION

X.±
.X±
.XX±
.XXX±
ANG±

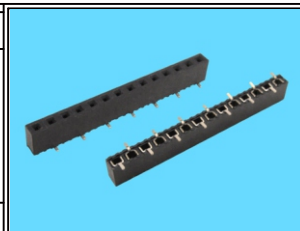

ORDER INFORMATION

F-V52X-1XxxR-LF
SERIES | 180°SMT | NON POST | HIGH 5.2mm | LEADFREE R TYPE FOOT | 1X03:03 WAY | 1X40:40 WAY

DESCRIPTION: Female Socket Dual Row SMD type (H=5.2)

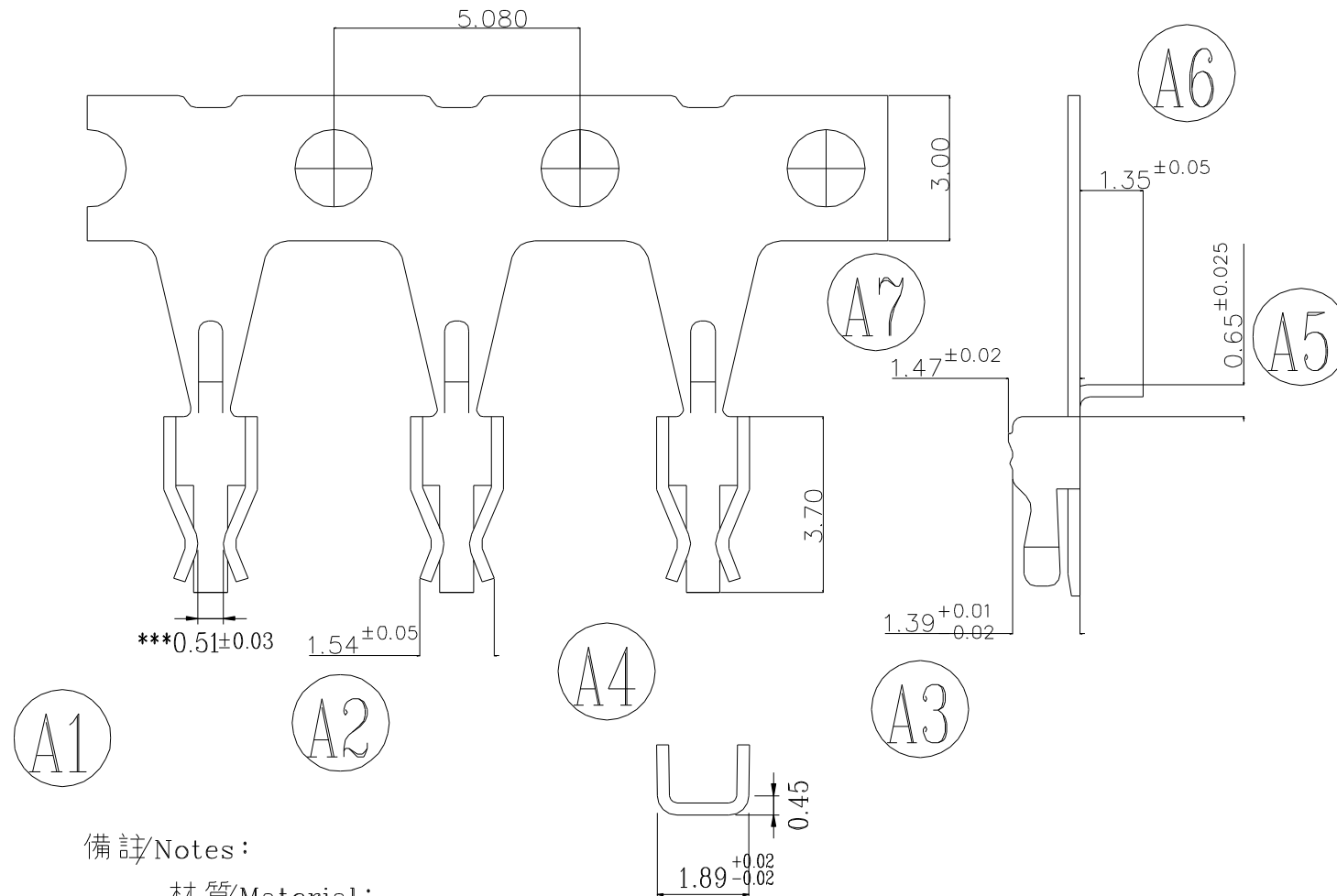

備註/Notes:

材質/Material:
 磷銅 厚0.25

MORETHANALL
 PCB CONNECTORS
 Cable ASSEMBLIES

煜倫股份有限公司

www.morethanall.com

RoHS Compliant

DRAWING BY CY

CHECKED BY GENIUS

UNIT / mm

SCALE 1:1

DATE

SIZE A4

TOLERANCES ARE

X. ± 0.20

.X ± 0.10

.XX ± 0.01

.XXX ±

ANG ± 1°

PJECTION

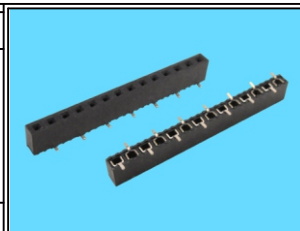

ORDER INFORMATION

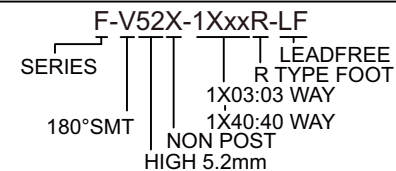

DESCRIPTION: