

- * Material : Nylon UL 94-V0
- * Current rating : 5A, AC/DC
- * Voltage rating : 250V, AC/DC
- * Color : Natural
- series headers
- * Mates with DPseries housings
- * 2, 3 & 4 circuits available

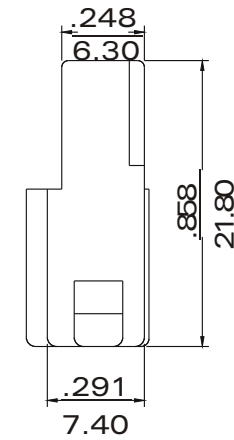
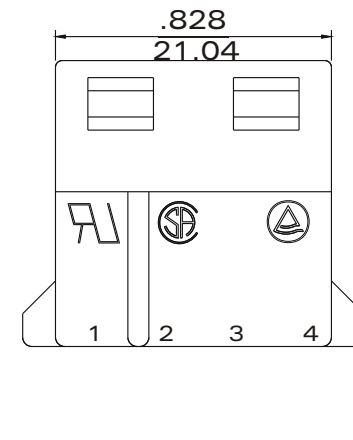
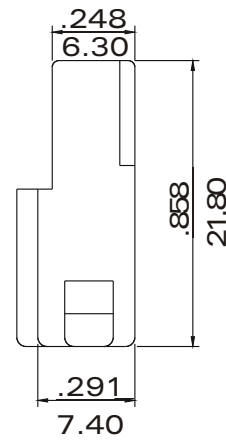
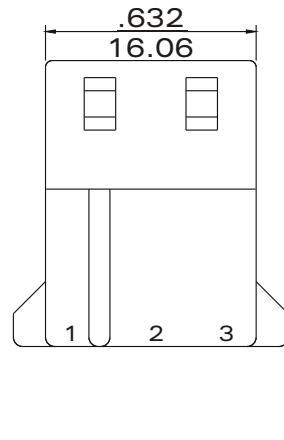
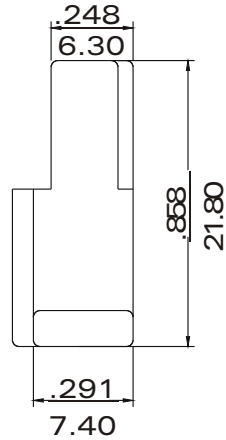
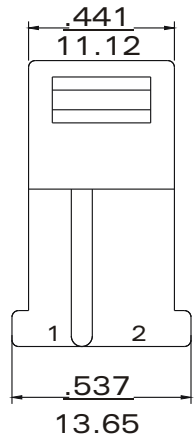
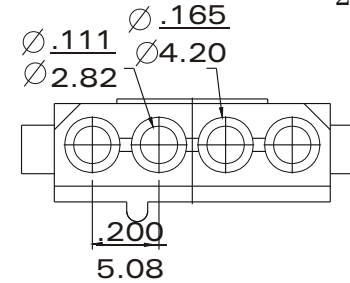
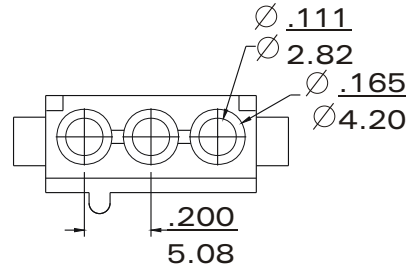
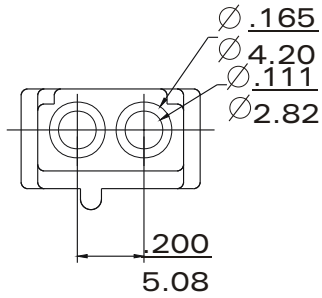

DP-S-02

DP-S-03

DP-S-04

inch
mm



PART NO. DP-S-xx

DWG NO. DP-S-xx

FILE NO.

UNIT / mm

SCALE 1:1

CHECKED BY CY

DRAWING BY

PROJECTION

TOLERANCES ARE

.X ± 0.2
.XX ±
.XXX ±
AWG

DESCRIPTION:

AREA

REVISIONS

HK

DATE

煜倫股份有限公司