

- 1 - All dimensions in mm [ Inch ]
- 2 - General tolerance : X.X=0.4  
X.XX=0.25
- 3 - Electrical rating : 6A 250VAC & 9A 125VAC
- 4 - Contact resistance : <20mΩ(initial)
- 5 - Insulation resistance : > 1000MΩ(500VDC between open contacts)
- 6 - Dielectric strength : >1500V 1 minute
- 7 - Mechanical life : >30000 cycles
- 8 - Electrical life : >10000 cycles
- 9 - Temperature rise at the terminal : Max.30°C
- 10 - Solder ability of terminal : Max350°C,3S(no pressure may be placed in the terminals when soldering by hand)

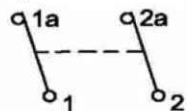

CIRCUIT DPST

POLE FUNCTION	OPTIONS OF FUNCTION		
	A	—	B
DPST	1-1a 2-2a	—	OFF

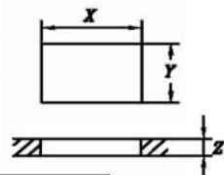

PANEL OUT-CUT		
Z	Y	X
0.7~1.25 [ .028~.049 ]	12.8~12.9 [ .504~.508 ]	19.2~19.3 [ .756~.760 ]
1.25~2.0 [ .049~.079 ]	12.8~12.9 [ .504~.508 ]	19.3~19.4 [ .760~.764 ]
2.0~3.0 [ .079~.118 ]	12.8~12.9 [ .504~.508 ]	19.5~19.6 [ .768~.772 ]

\* We keep the right to alter the dimension without notice.

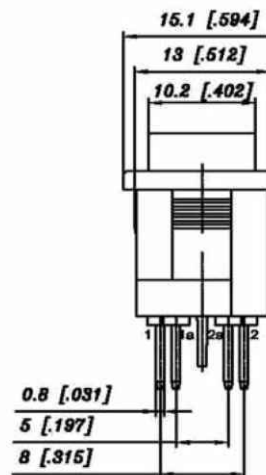
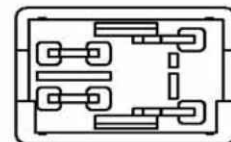
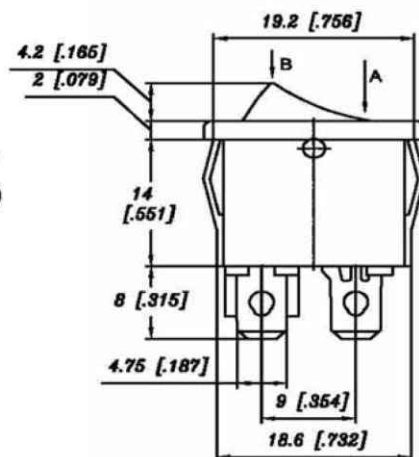
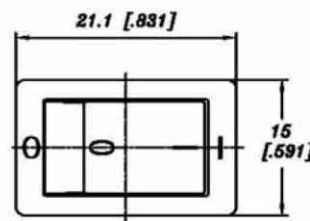

Color	Housing	Actuator
K(Black)	√	√
W(White)		
R(Red)		
G(Gray)		
O(Orange)		
B(Blue)		
Y(III. Yellow)		
M(III. Green)		
F(III. Blue)		
T(III. White)		
D(III. Red)		

RSW-S4PA-04-LF  
LEADFREE

RoHS Compliant

**MORETHANALL**  
CONNECTORS  
ASSEMBLIES

PART NO. RSW-S4PA-04

DWG NO. RSW-S4PA-04

FILE NO.

UNIT / mm

SCALE 1:1

CHECKED BY CY

DRAWING BY

PROJECTION

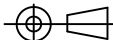

TOLERANCES ARE

.X ±  
.XX ±  
.XXX ±  
AWG

DESCRIPTION:

AREA

REVISIONS

HK

DATE

焯倫股份有限公司