

**MATERIALS**  
 1. HOUSING: HI-TEMP.(UL 94V-0).BLACK.  
 2. TERMINAL: COPPER ALLOY(T=0.15mm).GOLD PLATED OVER NICKEL.  
 3. COVER: STAINLESS STEEL(T=0.2mm)

**SPECIFICATION**  
 1. CURRENT RATING: 1.0 A. MAX  
 2. DIELECTRIC WITHSTANDING VOLTAGE: 500V AC R.M.S. FOR ONE MINUTE.  
 3. INSULATION RESISTANCE: 1000MΩMIN. AT 500V DC.  
 4. CONTACT RESISTANCE: 30mΩMAX  
 5. OPERATING TEMPERATURE: -40°C TO +85°C

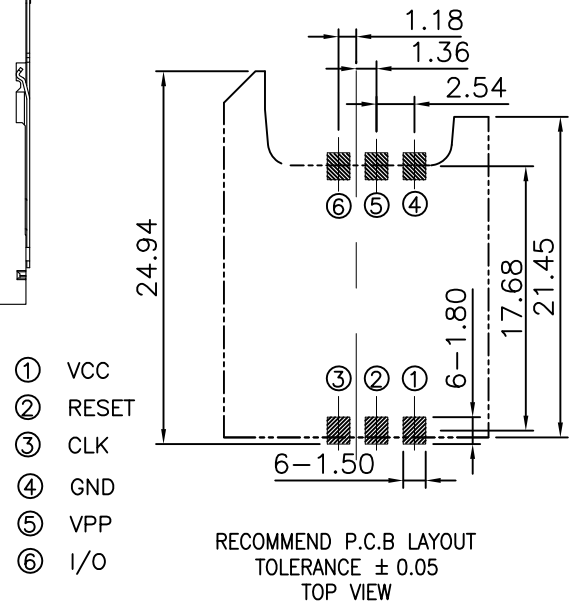

**RoHS Compliant**

TOLERANCES ARE

**MORETHANALL**  
 PCB CONNECTORS  
 Cable ASSEMBLIES  
 煜倫股份有限公司  
 www.morethanall.com

DRAWING BY CY		X. ± .X ± 0.30 .XX ± 0.25 .XXX ± 0.20 ANG ± 5°
CHECKED BY GENIUS		
UNIT / mm	SCALE 1 : 1	
DATE		
SIZE A4	PJECTION	

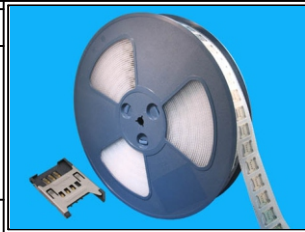

**ORDER INFORMATION**

SCV-W1718XR-06-LF  
 SERIES | | | | LEADFREE  
 | | | | 06 WAY  
 | | | | REEL  
 90°SMT | | | | NON POST  
 | | | | HIGH 1.80mm  
 | | | | PAD TO PAD 17.68mm

DESCRIPTION: SIM Card Socket 6Pin Hinge Type H=1.8mm ,Gold Flash Plating, Without Peg

END

Start

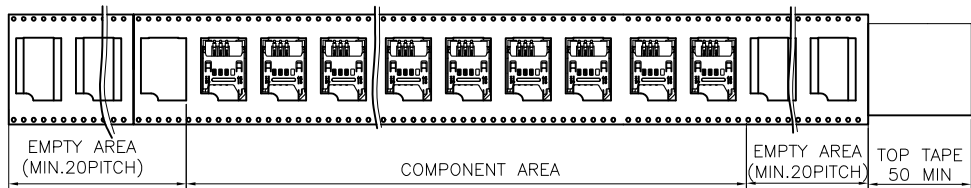

**PACKAGING SPECIFICATION:**

**1. MATERIAL**

- 1.1 Embossed Carrier Tape: PS Black
- 1.2 Top Cover Tape: PET 10-70g (Peel Speed 300mm/Minute)
- 1.3 Taping Reel: Plastic

**2. PACKING**

- 2.1 Quantity: 1000Piece/Reel

PEEL STRENGTH OF COVER TAPE:10~70g  
 peeling speed:300mm/minute  
 peeling angle:165to180degrees

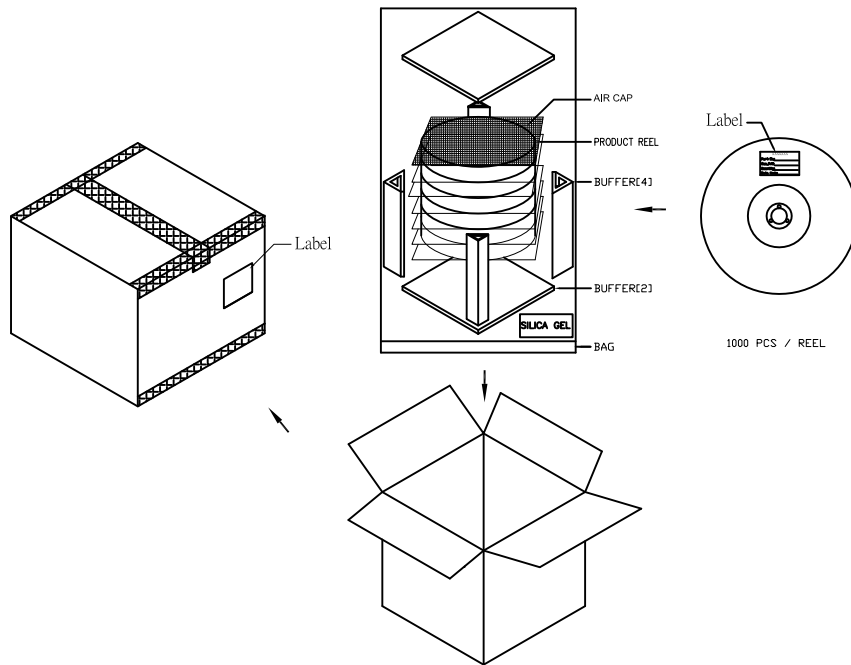
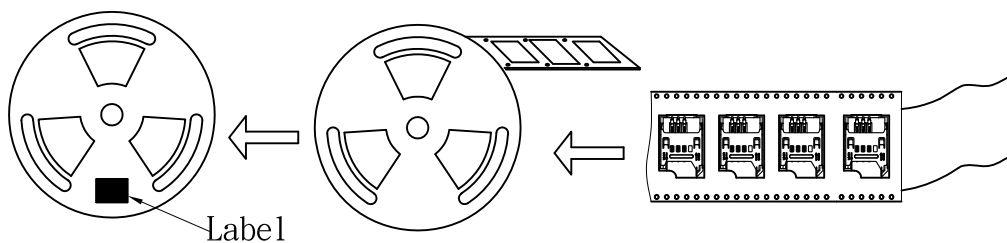
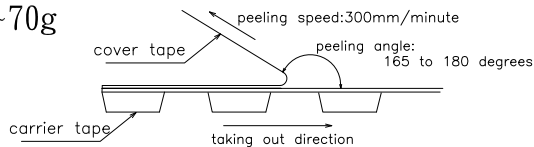

**RoHS Compliant**

TOLERANCES ARE

**MORETHANALL**  
 PCB CONNECTORS  
 Cable ASSEMBLIES

煜倫股份有限公司

www.morethanall.com

DRAWING BY CY

CHECKED BY GENIUS

UNIT / mm

SCALE 1 : 1

DATE

SIZE A4

X, ±  
 .X ± 0.30  
 .XX ± 0.25  
 .XXX ± 0.20  
 ANG ± 5°

PPOJECTION

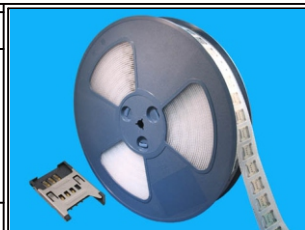

**ORDER INFORMATION**

SCV-W1718XR-06-LF  
 SERIES | | | LEADFREE  
 | | | 06 WAY  
 | | | REEL  
 90°SMT | | | NON POST  
 | | | HIGH 1.80mm  
 | | | PAD TO PAD 17.68mm

DESCRIPTION: SIM Card Socket Hinge Type H:1.8mm