

物質名稱	限值	測試方法
Pb(鉛)	<50PPM	IEC62321, IEC111, IECmethod, section11, 120r13
Cd(鎘)	<5PPM	IEC62321, IEC111, IECmethod, section11, 120r13
Hg(汞)	Not Detection	IEC62321, IEC111, IECmethod, section10
Cr(六價鉻)	Not Detection	IEC62321, IEC111
PBBs類	Not Detection	IEC62321, IEC111, IECmethod, section7
PBDES類	Not Detection	IEC62321, IEC111, IECmethod, section7

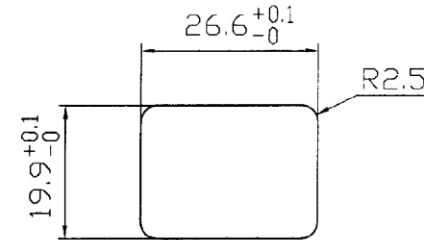
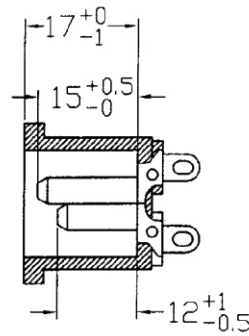
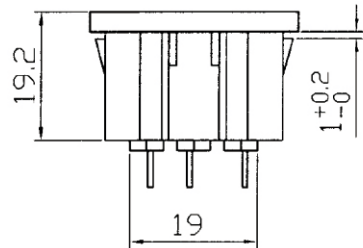
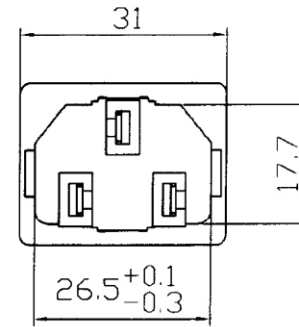
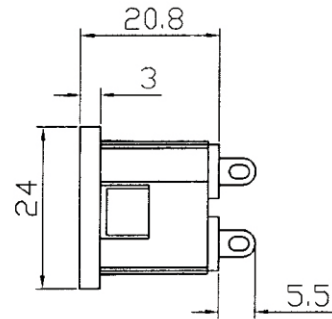
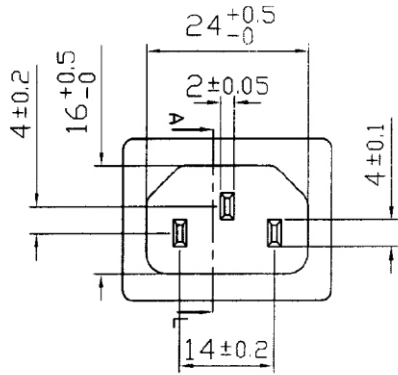

PANEL CUT-OUT

10A/15A 250V~

1. SOLDERING: PIN BRASS STRIP 0.8X3T TIN PLATING
2. CONTACT: PIN BRASS STRIP 2X4 TIN PLATING
3. BODY INSULATOR: NYLON 66

RoHS Compliant

TOLERANCES ARE



煜倫股份有限公司

www.morethanall.com

DRAWING BY CY

CHECKED BY GENIUS

UNIT / mm

SCALE 1:1

DATE

SIZE A4

PJECTION

X, ±  
.X ±  
.XX ±  
.XXX ±  
ANG ±



ORDER INFORMATION

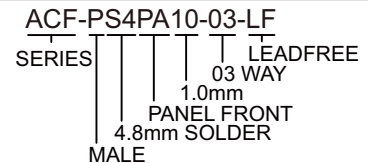

DESCRIPTION: