

SECTION A-A

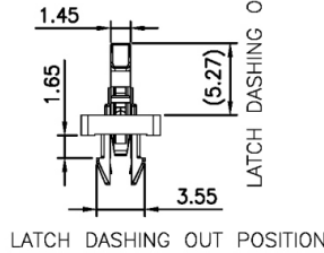

LATCH DASHING OUT POSITION

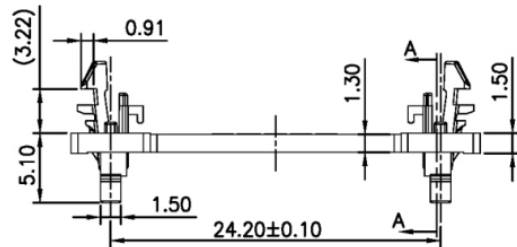
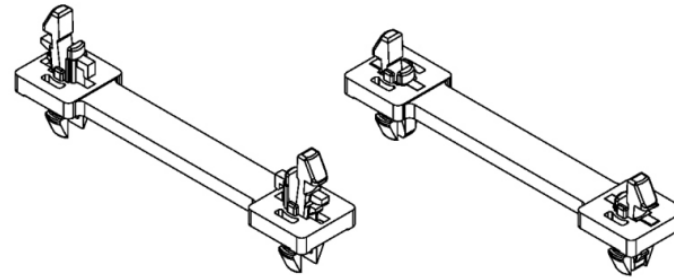
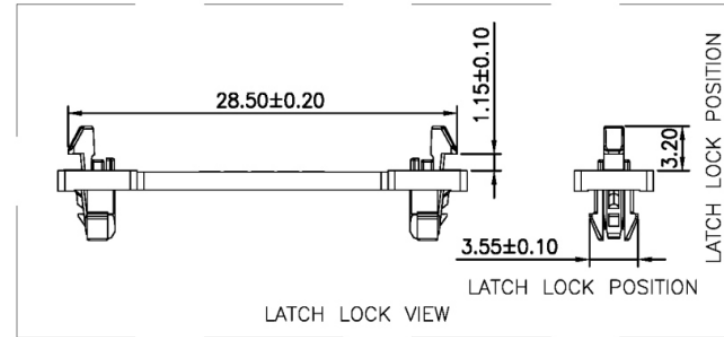

LATCH LOCK VIEW

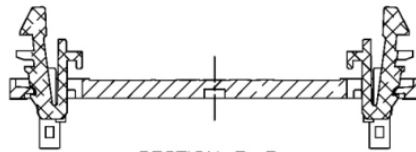

SECTION B-B

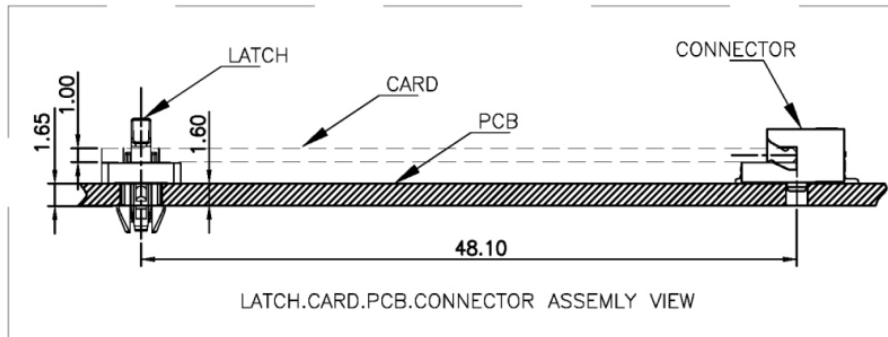

LATCH.CARD.PCB.CONNECTOR ASSEMBLY VIEW

NOTES:

- 1.MATERIAL: PC; COLOR: BLACK
- 2.ACCORDING TO THE ENVIROMENTAL REQUIREMENT,WARRANTY THE CONTROLLED HAZARDOUS SUBSTANCE SHOULD BE MEET LOTES'S SPECIFICATION

RoHS Compliant

TOLERANCES ARE

MORETHANALL
PCB CONNECTORS
Cable ASSEMBLIES

DRAWING BY CY
CHECKED BY GENIUS
UNIT / mm SCALE 1 : 1
DATE

X, ±
.X ±
.XX ±
.XXX ±
ANG ±

煜倫股份有限公司

www.morethanall.com

SIZE A4 PPROJECTION

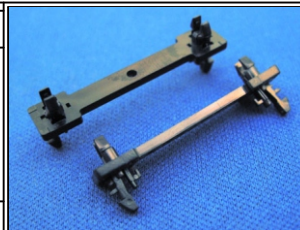

ORDER INFORMATION

MPCI-LP40-052-LF
SERIES | | | LEADFREE
| | | 52 WAY
| | | HIGH 4.0mm
| | | PLASTIC
| | | LATCH

DESCRIPTION: