

RECOMMEND P.C.B LAYOUT

備註/NOTE:

△ 1.安規/SAFETY:

- 1-1. Temperature rise: 0.3Aac/30Vac.
- 1-2. Insulation resistance: 500Vac/1min.
- 1-3. Dielectric withstanding voltage: 250Vac/0.5mA/1min.
- 1-4. Low level resistance: full scale voltage 20mV/current 10mA.
- 1-5. Durability: 12000cycles-200mm/min.

2.材質/MATERIAL:

- 2-1 膠芯/HOUSING: LCP.
- 2-2 端子/PIN: 磷銅/PHOSPHOR BRONZE.
- 2-3 鐵殼/SHELL: 磷銅/PHOSPHOR BRONZE.

3.電鍍/PLATING:

- 3-1 端子/PIN: GOLD 5u" △
- 3-2 鐵殼/SHELL: 霧錫/TIN.

RoHS Compliant

TOLERANCES ARE

MORETHANALL
PCB CONNECTORS
Cable ASSEMBLIES

煜倫股份有限公司

www.morethanall.com

DRAWING BY CY

CHECKED BY GENIUS

UNIT/mm SCALE 1:1

DATE

SIZE A4

X, ±
X, ±
.XX ±
.XXX ±
ANG ±

P PROJECTION

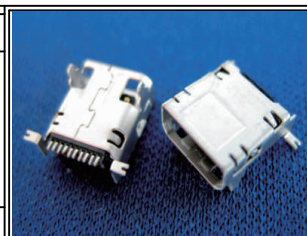

ORDER INFORMATION

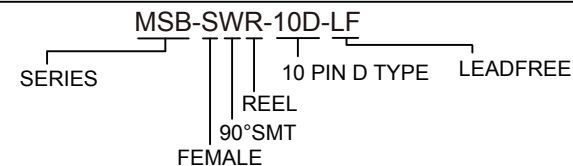

DESCRIPTION: MiniUsb 10(F) 板端SMT(鐵殼加深)

步驟一:

1. 將成品一一放入包裝盤內,依同一方向置入.
2. 包裝方式,如圖所示.
3. 一個包裝盤內放900pcs.

步驟二:

1. 一個紙箱可以裝10個包裝盤.
2. 每盤900pcs,每箱9000pcs.
3. 將包裝盤放入防水袋中,包裝完後再封箱.

步驟三:

1. 用膠帶將紙箱封實.
2. 將標籤貼於紙箱上.

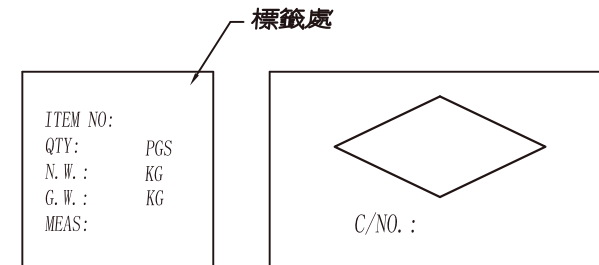
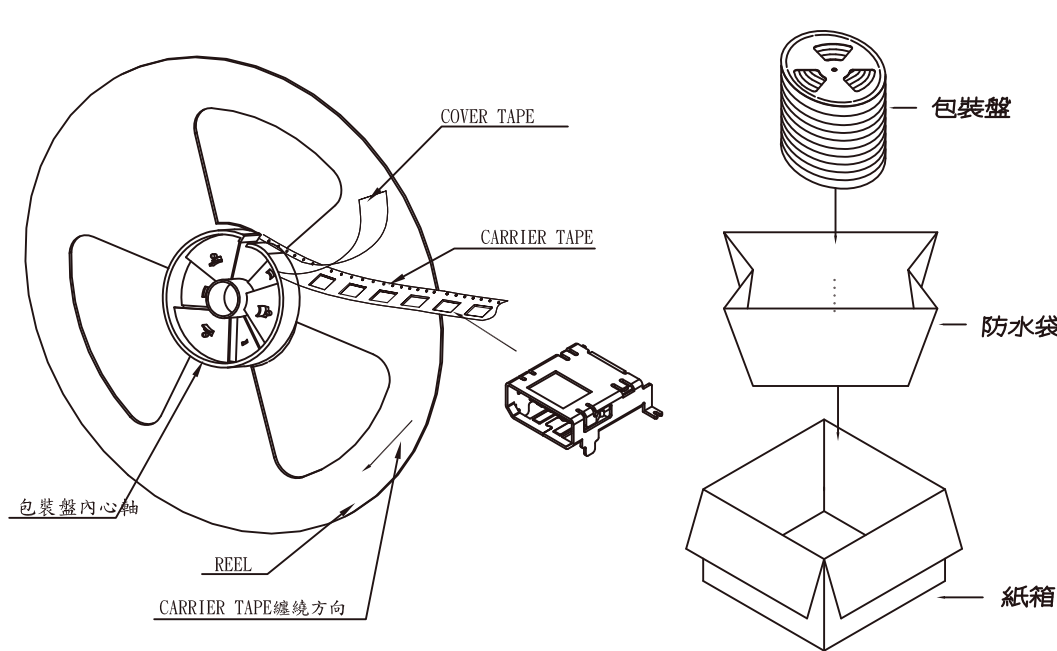

NOTE:

1. 若有未裝滿之零數箱,必須以緩衝材塞滿.
2. 在搬運過程中要輕拿輕放.
3. 載運輸中不可堆放過多,不可有重壓現象.
4. 在裝滿產品後,必須空留帶前和帶後15格以上,然後用紙膠布貼上.
5. 上帶在貼下帶時必須平整,且黏貼處不要出現氣泡.

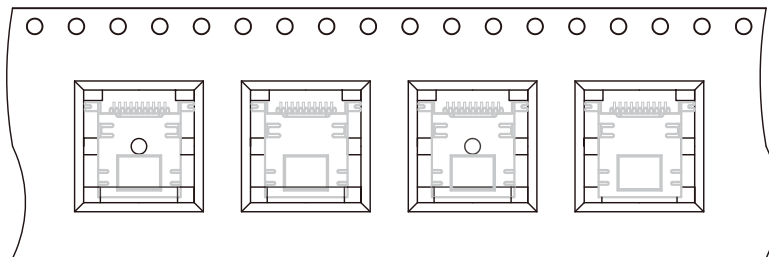

RoHS Compliant

TOLERANCES ARE

MORETHANALL
PCB CONNECTORS
Cable ASSEMBLIES

煜倫股份有限公司

www.morethanall.com

DRAWING BY CY

CHECKED BY GENIUS

UNIT/mm

SCALE 1:1

DATE

SIZE A4

PJECTION

X. ±
.X ± 0.20
.XX ± 0.10
.XXX ± 0.05
ANG ±

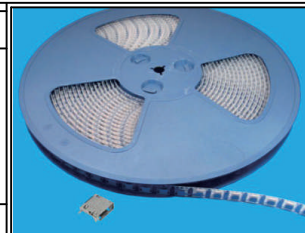

ORDER INFORMATION

MSB-SWR-10D-LF

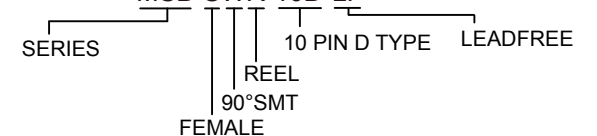

DESCRIPTION: