

SCHEMATIC		
DCJ-W54R-20	$\phi 2.0$	
DCJ-W54R-25	$\phi 2.5$	

T:1.6 Dimensions of PC board holes  
Tolerance :  $\pm 0.1$ (Printed-top view)

UNLESS OTHERWISE SPECIFIED, TOLERANCE ON DECIMAL:  $\pm 0.2$

LTR	PART NAME	QTY	MATERIAL	REMARK
6	COVER	1	PA9T	UL-94V0(BLACK)
5	HOUSING	1	PA9T	UL-94V0(BLACK)
4	PIN	1	C2680	MB:Cu Ni PLATED
3	CURVE PIECE	1	C2680 t=0.4	MB:Cu Ag PLATED
2	SPRING	1	C5191 t=0.3	MB:Cu Ag PLATED
1	CURVE PIECE	1	C2680 t=0.4	MB:Cu Ag PLATED

RoHS Compliant

TOLERANCES ARE

**MORETHANALL**  
PCB CONNECTORS  
Cable ASSEMBLIES

煜倫股份有限公司

www.morethanall.com

DRAWING BY CY

CHECKED BY GENIUS

UNIT/mm SCALE 1:1

DATE

SIZE A4

X.  $\pm$   
.X  $\pm$   
.XX  $\pm$   
.XXX  $\pm$   
ANG  $\pm$

PJECTION

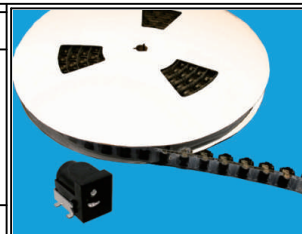

ORDER INFORMATION

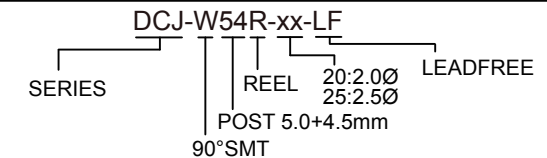

DESCRIPTION: DC POWER JACK

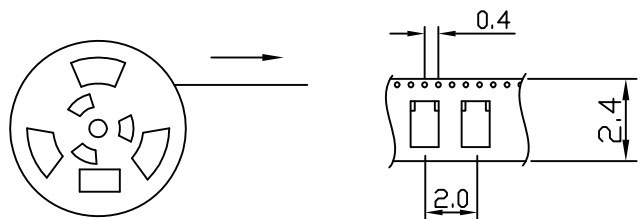

Reel packing

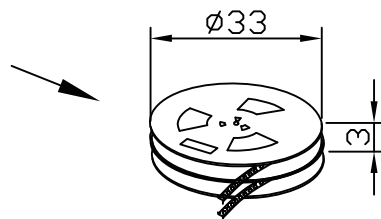

Reel packing(250pcs/Reel)

產品系列:SMT DC JACK  
 產品型號: DCJ-W54R-xx

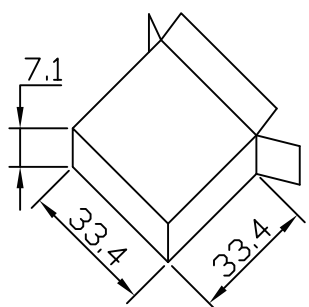

Inner box(2X250=500pcs)

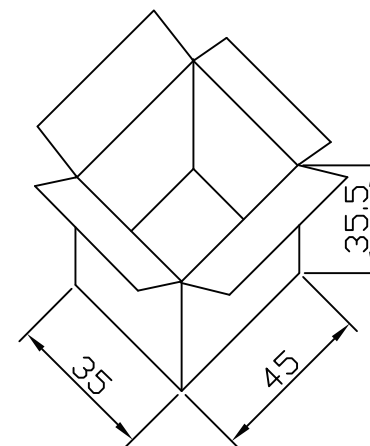
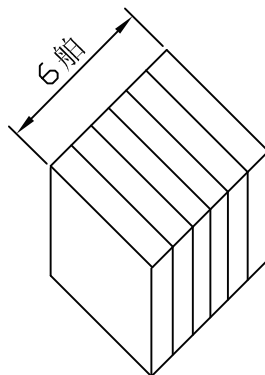

Carton(6X500=3000pcs)

淨重:8.5kg  
 毛重:12.5kg

**RoHS Compliant**

TOLERANCES ARE

**MORETHANALL**  
 PCB CONNECTORS  
 Cable ASSEMBLIES

煜倫股份有限公司

www.morethanall.com

DRAWING BY CY

CHECKED BY GENIUS

UNIT/mm SCALE 1:1

DATE

SIZE A4

X. ±  
 .X ±  
 .XX ±  
 .XXX ±  
 ANG ±

P PROJECTION

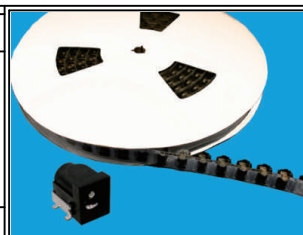

**ORDER INFORMATION**

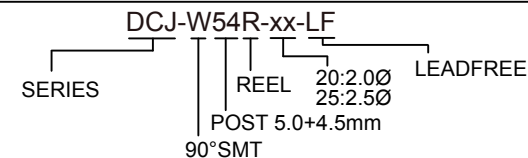

DESCRIPTION: DC POWER JACK