

1 2 3 4 5 6 7 8 9 0

J
I
H
G
F
E
D
C
B
A

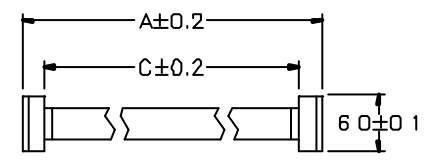

Position	Dimension			
	A±0.1	B	C±0.1	D±0.1
20	18.52	11.43	15.99	7.300
26	22.33	15.24	19.80	9.205
32	26.14	19.05	23.60	11.110
34	27.41	20.32	24.88	11.745
40	31.22	24.13	28.68	13.650
50	37.57	30.48	35.04	16.825
52	38.84	31.75	36.30	17.460
60	43.92	36.83	41.40	20.000
68	49.00	41.91	46.46	22.540
80	56.62	49.53	54.09	26.350
100	69.32	62.23	66.79	32.700

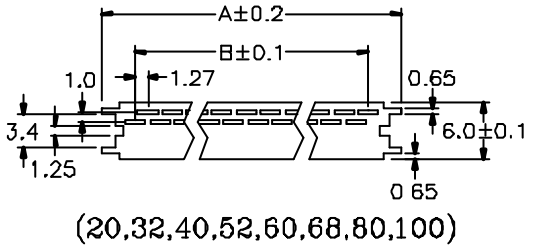
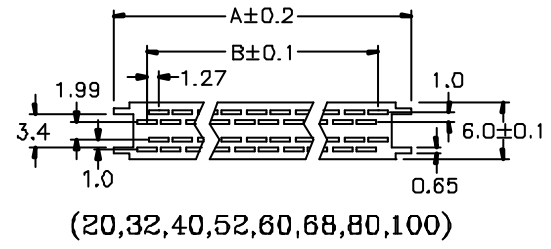
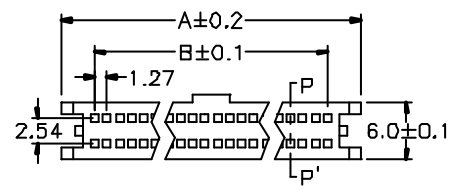
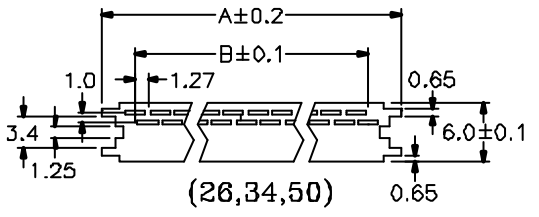
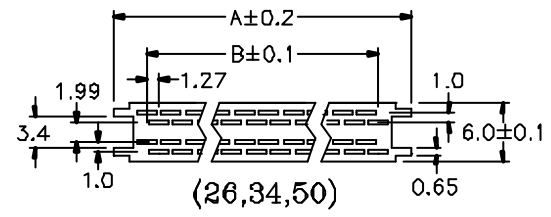
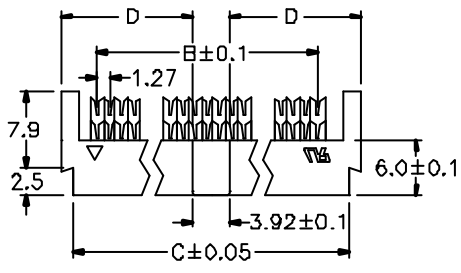
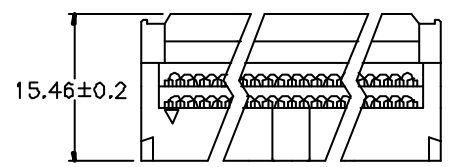
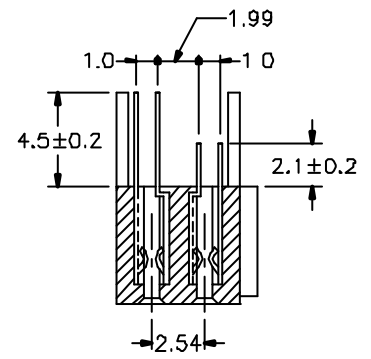
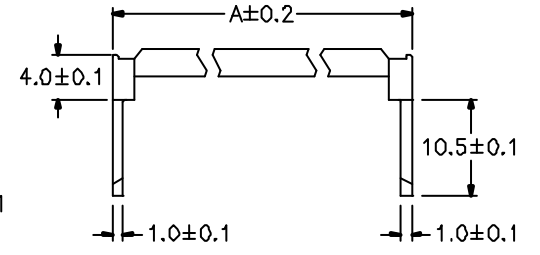
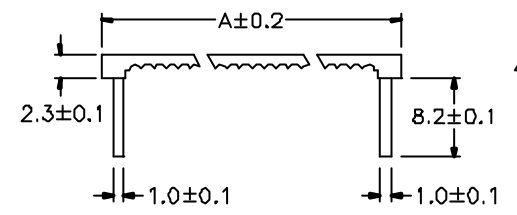
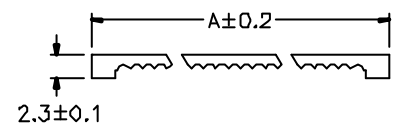

HF-C3-xxx-LF
LEADFREE
RoHS Compliant

MORETHANALL
CONNECTORS
ASSEMBLIES

焯倫股份有限公司

PART NO. HF-C3-xxx		CHECKED BY CY		TOLERANCES ARE .X ±0.2 .XX ± .XXX ± AWG	DESCRIPTION: I.D.C Socket 1.27mmX2.54mm	AREA	REVISIONS	HK	DATE
DWG NO. HF-C3-xxx		DRAWING BY							
FILE NO.		PROJECTION							
UNIT / mm	SCALE 1:1								