

#	PART NAME	QTY	MATERIAL	PLATING	REMARKS
	BODY	1	NYLON		BLACK(U194V-0)
2	MAIN TERMINAL A	1	*CTR-M 0.3t	Ag	(TIP CONTACT)
5	MAIN TERMINAL B	1	PBSR-H 0.2t	Ag	(RING CONTACT)
3	FIX TERMINAL A	1	BsR2-H 0.25t	Ag	
4	FIX TERMINAL B	1	BsR2-H 0.25t	Ag	
1	EARTH TERMINAL	1	PBSR-H 0.2t	Sn	(SLEEVE CONTACT)
6	OUTER RING T.		PBSR-H 0.2t	Au	(OUTER RING C.)

*or BeCuR-M 0.3t

RoHS Compliant

TOLERANCES ARE

MORETHANALL
PCB CONNECTORS
Cable ASSEMBLIES
煜倫股份有限公司

DRAWING BY CY
CHECKED BY GENIUS
UNIT / mm SCALE 1 : 1
DATE

X, ±
.X ±
.XX ±
.XXX ±
ANG ±

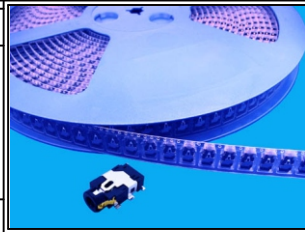

ORDER INFORMATION

EJ-W35UR-06DS-LF
SERIES REEL 6P4C LEADFREE
POST 3+5mm
90°SMT

www.morethanall.com

SIZE A4 PROJECTION

DESCRIPTION:

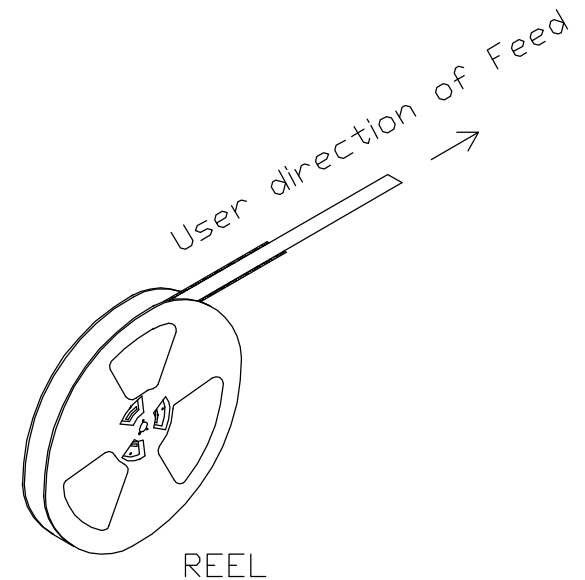
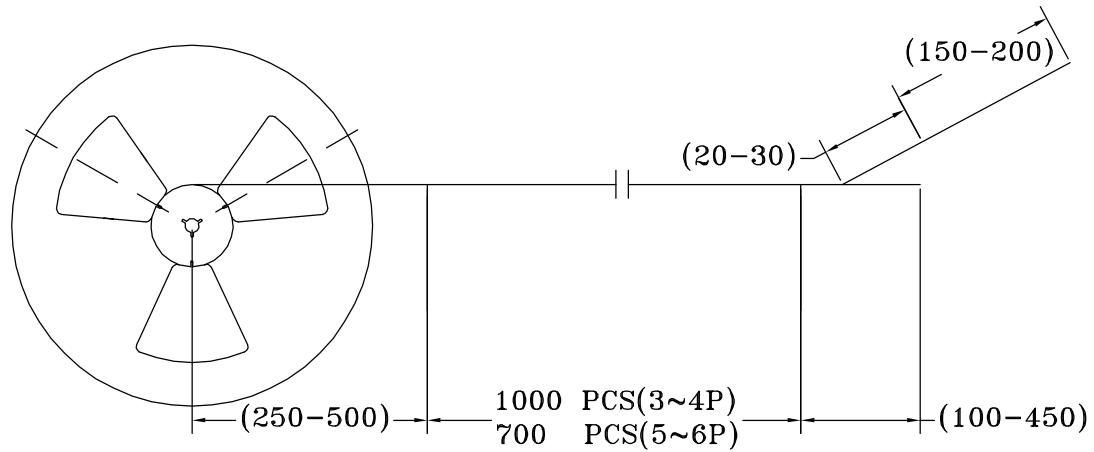

Direction of Feed

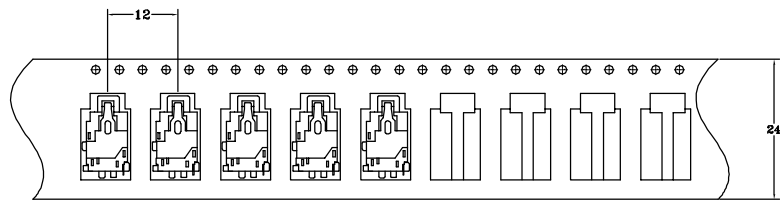

3/4P

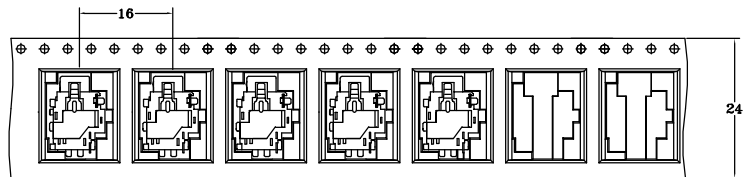

5P

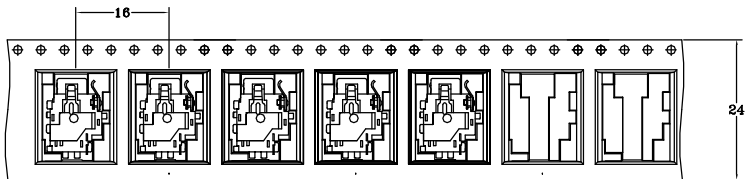

6P

RoHS Compliant

TOLERANCES ARE

MORETHANALL
PCB CONNECTORS
Cable ASSEMBLIES

DRAWING BY CY

X, ±

CHECKED BY GENIUS

.X ±

UNIT / mm

SCALE 1 : 1

.XXX ±

DATE

ANG ±

SIZE A4

P PROJECTION

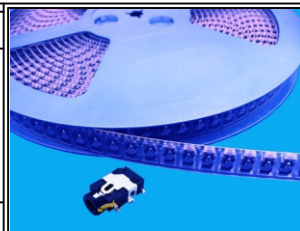

ORDER INFORMATION

EJ-W35UR-06DS-LF
SERIES REEL 6P4C LEADFREE
POST 3+5mm
90°SMT

煜倫股份有限公司

www.morethanall.com

DESCRIPTION: