

PANEL LAYOUT

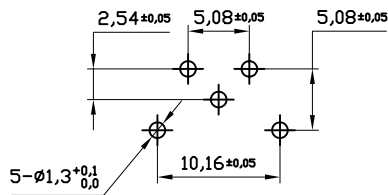

P.C.B LAYOUT

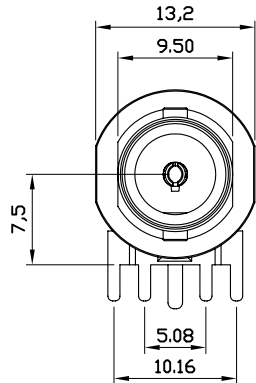
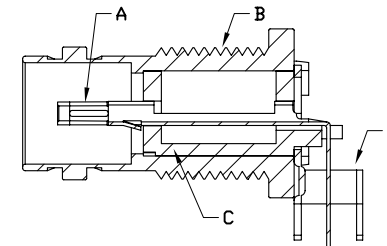
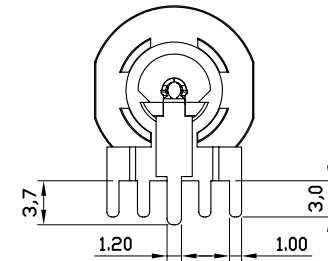
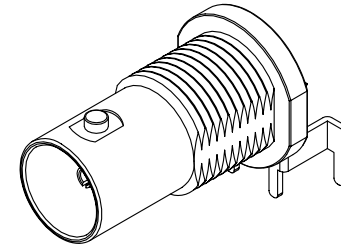
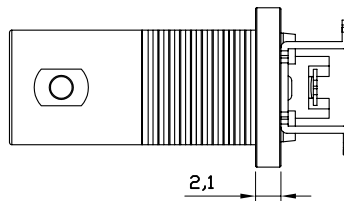
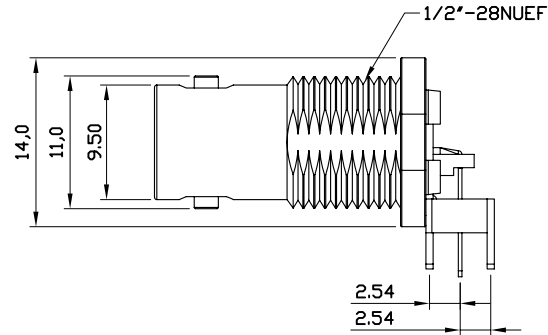
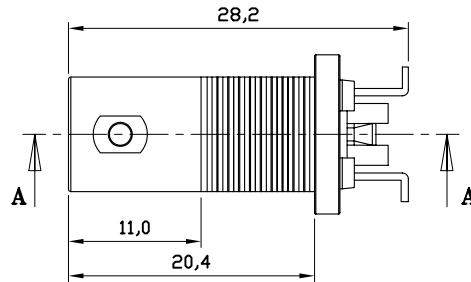

PROFILE CHART A-A

D	接地片	T=0.6mm黃銅、鍍錫80U"	1pcs
C	絕緣體	PBT+15%GF UL94-V0本色	1pcs
B	本體	鋅合金壓鑄、鍍銀	1pcs
A	中心針	T=0.3mm磷青銅、鍍金1U"	1pcs
NO	NAME	SPECIFICATION	QTY

RoHS Compliant

TOLERANCES ARE

MORETHANALL
PCB CONNECTORS
Cable ASSEMBLIES

DRAWING BY CY

CHECKED BY GENIUS

UNIT / mm

SCALE 1 : 1

DATE

SIZE A4

PJECTION

X. ±
.X ±
.XX ±
.XXX ±
ANG ±



ORDER INFORMATION

BNC-JR14XFM-75-LF
SERIES | | | | LEADFREE
JACK | | | | 75 OHM
DIP 90° | | | | FULL METAL
NON NUT/WASHER
HIGH 14.0mm

DESCRIPTION: BNC FEMALE R/A PANEL MOUNT 75 OHM

煜倫股份有限公司

www.morethanall.com