

PCB LAYOUT

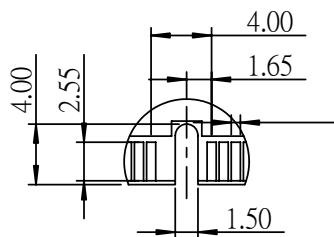

A (2 : 1)

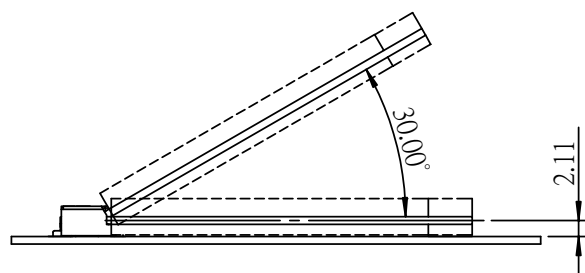
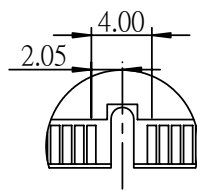

B (2 : 1)

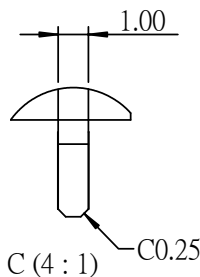

C (4 : 1)

MORETHANALL
CONNECTORS
ASSEMBLIES

煜倫股份有限公司

PART NO. MPC1-W40R-052

DWG NO. MPC1-W40R-052

FILE NO.

UNIT / mm

SCALE 1:1

CHECKED BY CY

DRAWING BY

PROJECTION

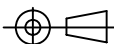

TOLERANCES ARE

.X ± 0.2

.XX ±

.XXX ±

AWG

DESCRIPTION:

AREA

REVISIONS

HK

DATE

MATERIAL	P/N	REMARKS
1 REEL	REEL-RA344	H=53.6max
2 COVER	REEL-UC375	W= 37.5m m
3 CARRIER TAPE	REEL-071LAB4401	W= 44m m
4 LABEL(For RaHS)	CTP-00002	1 LABEL/CARTON
5 LABEL(For RaHS)	CTB-00004	1 LABEL/REEL
6 LABEL(For RaHS)	CTB-00005	1 LABEL/REEL
7 CARTON	CTN-C100Y	CARTON/6 REEL/3900pcs
8 POLY BAG	P-0001	1 BAG/CARTON
9 GUARD	CTN-N3025	4 GUARDS/CARTON

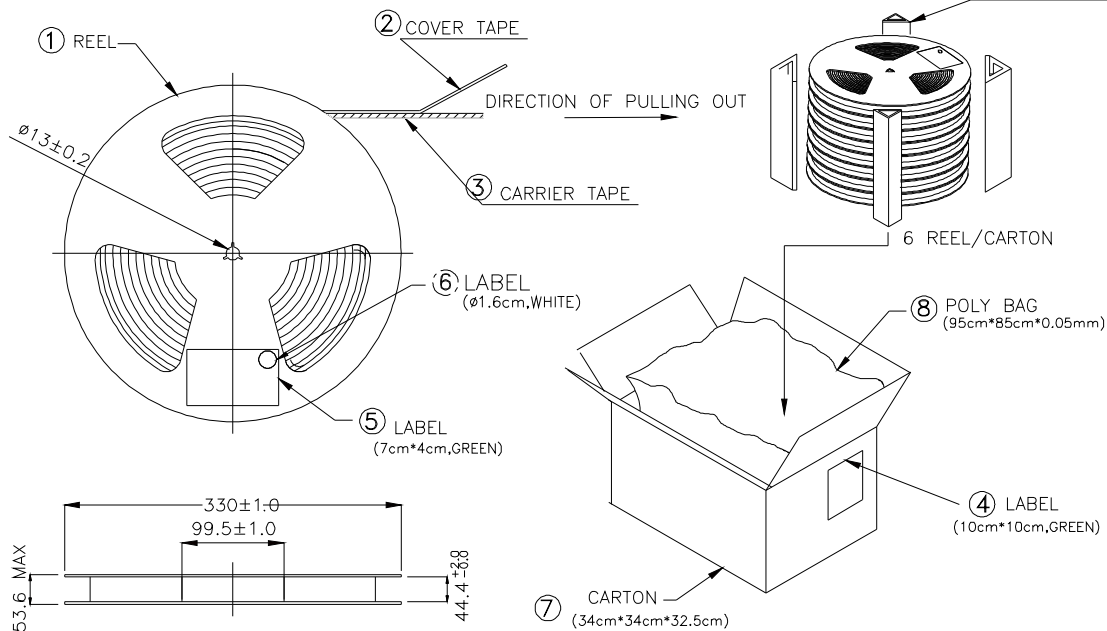
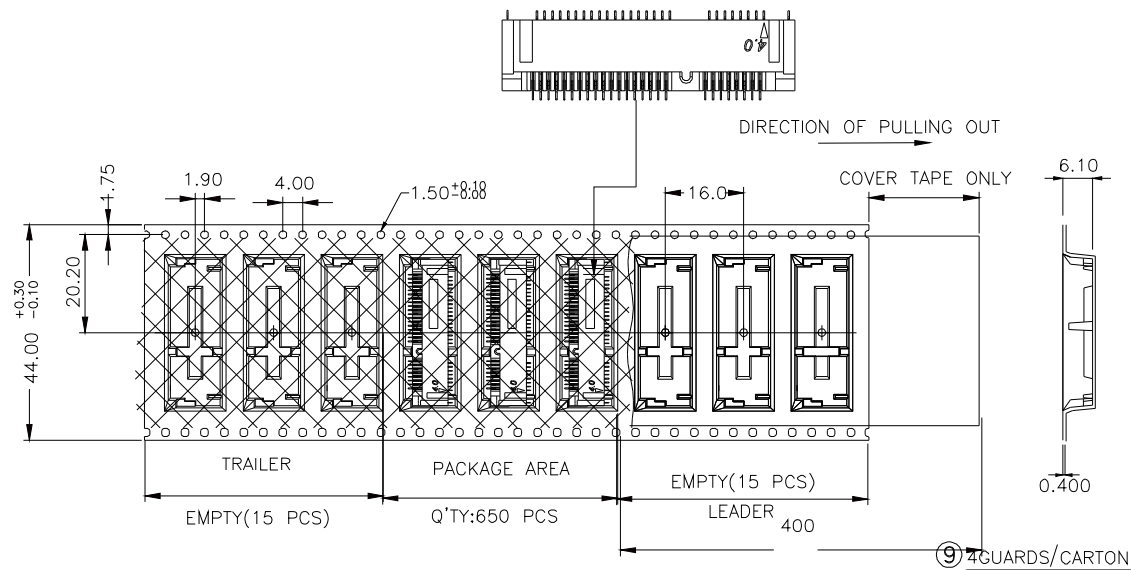

MORETHANALL
CONNECTORS
ASSEMBLIES

PART NO. MPC-I-W40R-052

DWG NO. MPC-I-W40R-052

CHECKED BY CY

TOLERANCES ARE

DESCRIPTION: PACKING INFORMATION

FILE NO.

DRAWING BY

.X ±
.XX ±
.XXX ±
AWG

AREA REVISIONS HK DATE

焯倫股份有限公司

UNIT / mm

SCALE 1:1

PROJECTION

