

NOTE:

1.MATERIAL:

- a.Insulator:High temperature thermoplastic with g.f,UL94v-0
- b.Contact:Copper alloy
- c.Shell:Copper alloy

2.ELECTRICAL CHARACTERISTICS

- a.Current rating:1.0A Max
- b.Dielectric withstanding voltage:750v(Ac)
- c.Contact resistance:30 mΩ Max
- d.Insulation resistance:1000 MΩ Min

3.ENVIRONMENTAL

- a.Temperature range:-40°C~+60°C

4.MECHANICAL CHARACTERISTICS

- a.Mating force:3.5 kgf Max
- b.Unmating force:1.0 kgf Min

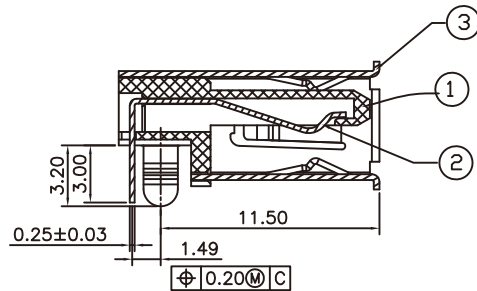

SECTION A-A

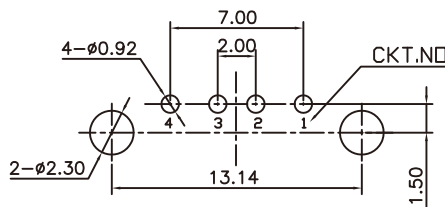
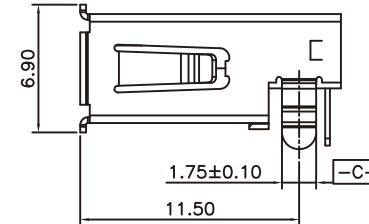
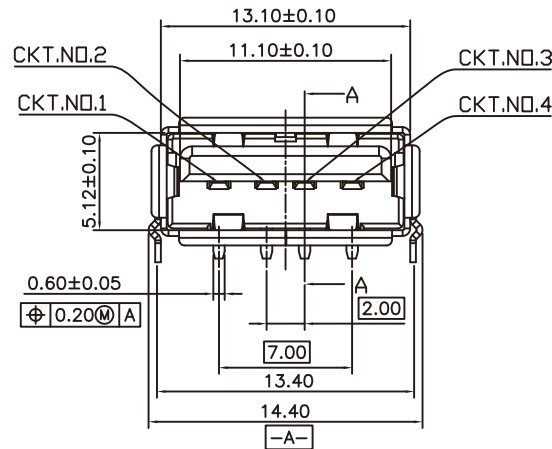

P.C.B LAYOUT
TOLERANCE:±0.10

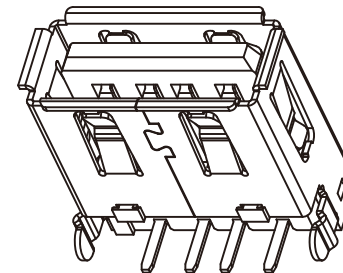

RoHS Compliant

TOLERANCES ARE

MORETHANALL
PCB CONNECTORS
Cable ASSEMBLIES

DRAWING BY CY

CHECKED BY GENIUS

UNIT/mm

SCALE 1:1

DATE

SIZE A4

X, ±
.X ±
.XX ±
.XXX ±
ANG ±

PJECTION

煜倫股份有限公司

www.morethanall.com

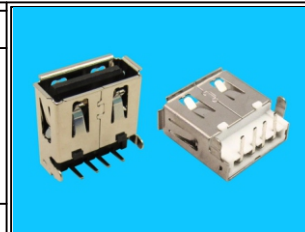

ORDER INFORMATION

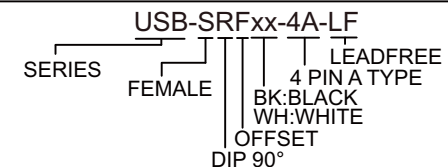

DESCRIPTION: USB A母單層沉板式-90°DIP